





SONDER-WERKZEUGHALTER



SPECIAL TOOLHOLDERS



СПЕЦИАЛЬНЫЕ РЕЗЦЕДЕРЖАТЕЛИ



PORTEOUTILS SPECIAUX



PORTAUTENSILI SPECIALI



专用刀柄



GILDEMEISTER TOOLHOLDERS

PORTAUTENSILI GILDEMEISTER

Pag. 379-388

MORI SEIKI TOOLHOLDERS / CMZ

PORTAUTENSILI MORI-SEIKI

Pag. 389-394

OKUMA TOOLHOLDERS

PORTAUTENSILI OKUMA

Pag. 395-408

NAKAMURA TOME TOOLHOLDERS

PORTAUTENSILI NAKAMURA

Pag. 409-412

DOOSAN PUMA TOOLHOLDERS - BMT 45 /55/65/75

PORTAUTENSILI DEWOO PUMA

Pag. 413-418

MAZAK TOOLHOLDERS

PORTAUTENSILI MAZAK

Pag. 419-421

WFL TOOLHOLDERS

PORTAUTENSILI WFL

Pag. 422

TAKISAWA TOOLHOLDERS

PORTAUTENSILI TAKISAWA

Pag. 423

YOU JI TOOLHOLDERS

PORTAUTENSILI YOU JI

Pag. 424

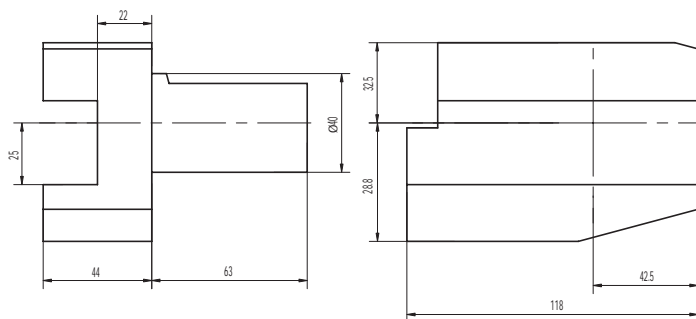
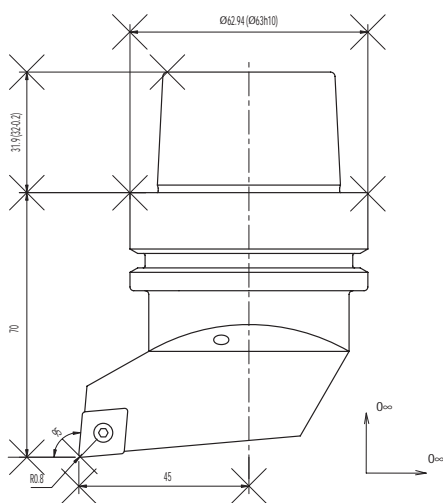
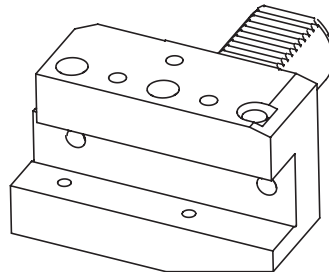
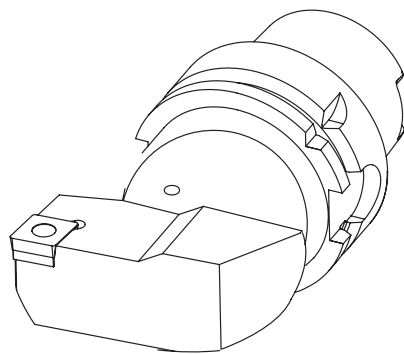

Auf Anfrage sind Dispositionszeichnungen im dxf Format mit entsprechenden Massen verfügbar.



On request we can send you general layouts in dxf format with the relative dimensions.



По запросу мы готовы выслать Вам общий чертеж в формате dxf с соответствующими размерами.



Sur demande les dessins d'avant-projet en format dxf sont disponibles avec les relatives cotes.



Sono disponibili a richiesta i disegni di massima in formato dxf con relative quote di ingombro.



如有要求，我们可以发送DXF格式的带有相关参数的总体设计。

GILDEMEISTER (VDI30)

CTX 210/310/410 V3/V1 - CTX 320/420 V3
 CTX Alpha 300/500 V3
 CTX Beta 500/800/1250 V3 (option)
 CTV 160

AXIAL TURRET

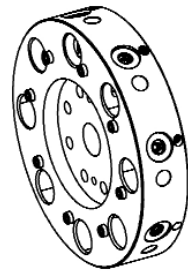
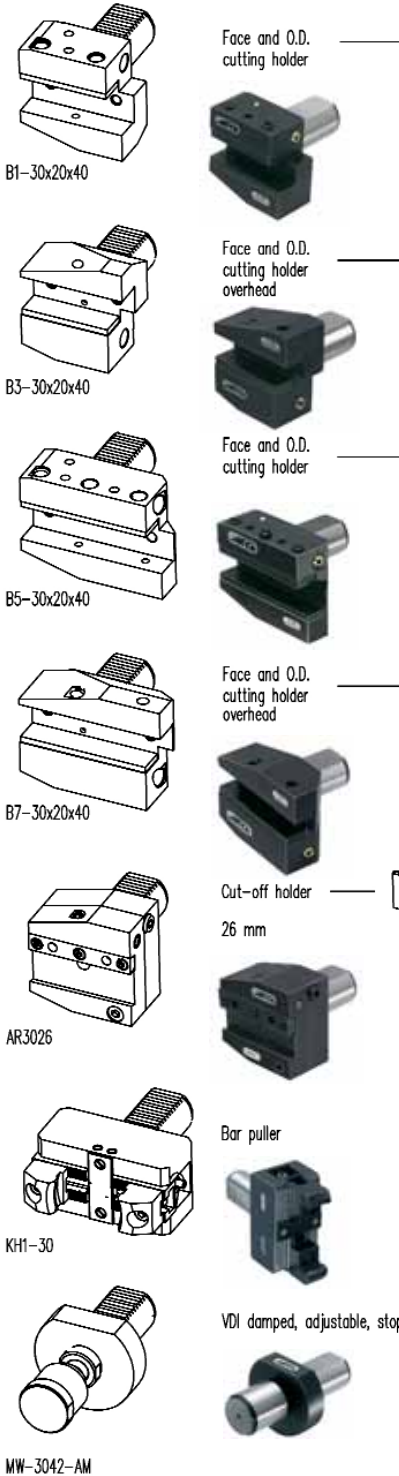

ACCESSORIES



Boring bar sleeve $\varnothing 25$ mm

- 115-62574 ($\varnothing 8$ mm)
- 115-62575 ($\varnothing 10$ mm)
- 115-62576 ($\varnothing 12$ mm)
- 115-62577 ($\varnothing 16$ mm)
- 115-62578 ($\varnothing 20$ mm)

Boring bar sleeve $\varnothing 32$ mm

- 165-63223 ($\varnothing 8$ mm)
- 165-63224 ($\varnothing 10$ mm)
- 165-63225 ($\varnothing 12$ mm)
- 165-63226 ($\varnothing 16$ mm)
- 165-63227 ($\varnothing 20$ mm)
- 165-63228 ($\varnothing 25$ mm)

Boring bar sleeve $\varnothing 40$ mm

- 165-64075 ($\varnothing 8$ mm)
- 165-64076 ($\varnothing 10$ mm)
- 165-64077 ($\varnothing 12$ mm)
- 165-64078 ($\varnothing 16$ mm)
- 165-64079 ($\varnothing 20$ mm)
- 165-64080 ($\varnothing 25$ mm)
- 165-64081 ($\varnothing 32$ mm)

Toolholder for insert drill

- E1-30x06WN ($\varnothing 6$ mm)
- E1-30x08WN ($\varnothing 8$ mm)
- E1-30x10WN ($\varnothing 10$ mm)
- E1-30x12WN ($\varnothing 12$ mm)
- E1-30x16 ($\varnothing 16$ mm)
- E1-30x20 ($\varnothing 20$ mm)
- E1-30x25 ($\varnothing 25$ mm)
- E1-30x32 ($\varnothing 32$ mm)
- E1-30x40 ($\varnothing 40$ mm)

Toolholder for boring bar

- E2-30x6 ($\varnothing 6$ mm)
- E2-30x8 ($\varnothing 8$ mm)
- E2-30x10 ($\varnothing 10$ mm)
- E2-30x12 ($\varnothing 12$ mm)
- E2-30x16 ($\varnothing 16$ mm)
- E2-30x20 ($\varnothing 20$ mm)
- E2-30x25 ($\varnothing 25$ mm)
- E2-30x32 ($\varnothing 32$ mm)
- E2-30x40 ($\varnothing 40$ mm)

Double holder for boring bar

E7-30x25 ($\varnothing 25$ mm)

Toolholder with cylindrical shank

137-00041 ($\varnothing 40$ mm/HSK50A+C)

Collet chuck

- E4-30x16 (ER16)
- E4-30x20 (ER20)
- E4-30x25 (ER25)
- E4-30x32 (ER32)
- E4-30x40 (ER40)

Drilling chuck

- KS2-30-13 ($\varnothing 1$ - $\varnothing 13$ mm)
- KS2-30-16 ($\varnothing 3$ - $\varnothing 16$ mm)

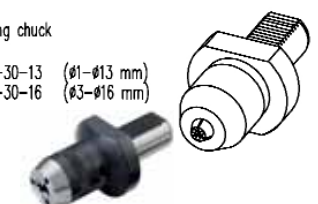
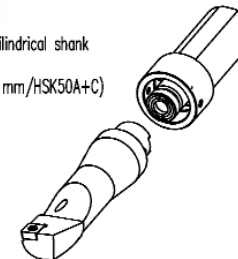
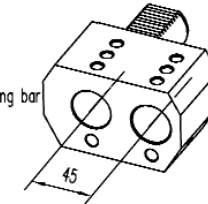
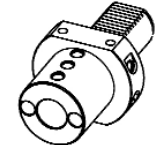
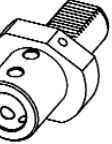

GILDEMEISTER (VDI30)

CTX 310/410 V4/V6 - CTX 320 V4/V6
 CTX 420 V4/V6 (option) - CTX Alpha 300 V4
 CTX Alpha 500 V 4/V6
 CTX Beta 500/800/1250 V4/V6 (option)
 TWIN 42/65/102
 SPRINT 65/50

RADIAL TURRET

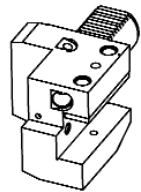

C1-30x20x70

Face and O.D. cutting holder

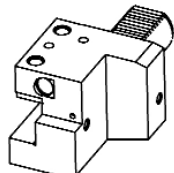

C2-30x20x70

Face and O.D. cutting holder

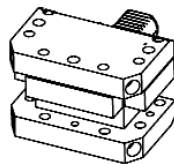

113-53003

Face and O.D. cutting holder

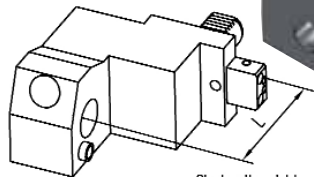

115-53015 (L=85)
115-53017 (L=100)

Single site, right

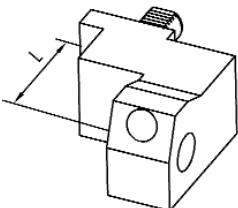

115-53016 (L=85)
115-53018 (L=100)

Single site, left

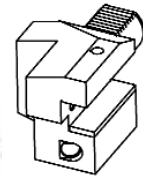

C3-30x20x70

Face and O.D. cutting holder overhead



Face and O.D. cutting holder overhead

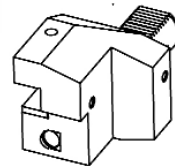

C4-30x20x70

Face and O.D. cutting holder

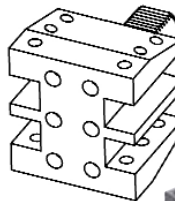

112-13013



117-53001

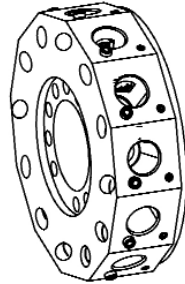

Qualified tool
20x20 mm

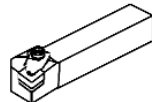

Cut-off holder
26 mm

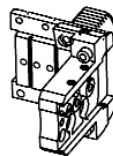

VDI30/VDI30 ADAPTORS

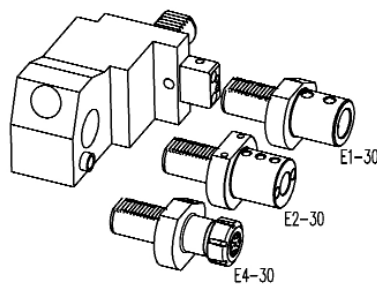

E1-30

E2-30

E4-30

Single site, right

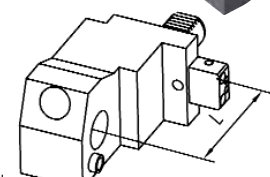

115-53019 (L=85)
115-53021 (L=100)

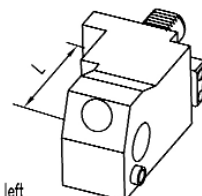

115-53020 (L=85)
115-53022 (L=100)

Single site, left



GILDEMEISTER (VDI30)

CTX310/410 V4/V6 - CTX 320 V4/V6
 CTX420 V4/V6 (option) - CTX Alpha 300 V4
 CTX Alpha 500 V4/V6
 CTX Beta 500/800/1250 V4/V6 (option)
 TWIN 42/65/102
 SPRINT 65/50

RADIAL TURRET

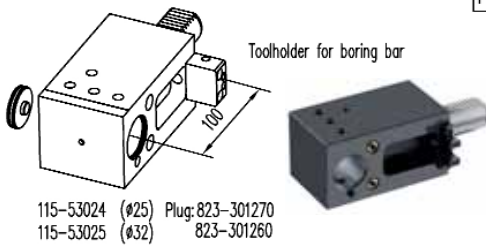

Toolholder for boring bar

115-53024 (Ø25) Plug: 823-301270
 115-53025 (Ø32) 823-301260

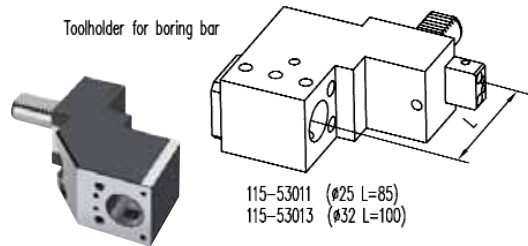

Toolholder for boring bar

115-53011 (Ø25 L=85)
 115-53013 (Ø32 L=100)

ACCESSORIES

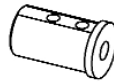

Boring bar sleeve Ø25 mm

165-62519 (Ø6 mm)
 165-62520 (Ø8 mm)
 165-62521 (Ø10 mm)
 165-62522 (Ø12 mm)

Boring bar sleeve Ø32 mm

165-63301 (Ø6 mm)
 165-63302 (Ø8 mm)
 165-63303 (Ø10 mm)
 165-63304 (Ø12 mm)

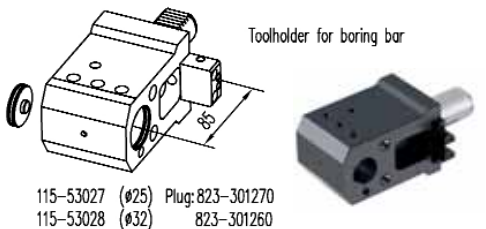

Toolholder for boring bar

115-53027 (Ø25) Plug: 823-301270
 115-53028 (Ø32) 823-301260

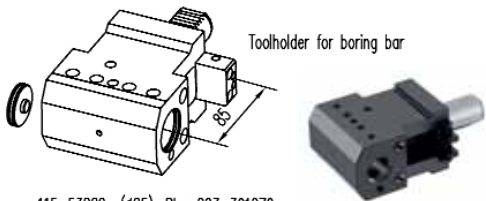

Toolholder for boring bar

115-53029 (Ø25) Plug: 823-301270
 115-53030 (Ø32) 823-301260

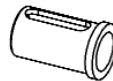

Boring bar sleeve Ø25 mm

165-62523 (Ø16 mm)
 165-62524 (Ø20 mm)

Boring bar sleeve Ø32 mm

165-63305 (Ø16 mm)
 165-63306 (Ø20 mm)
 165-63307 (Ø25 mm)

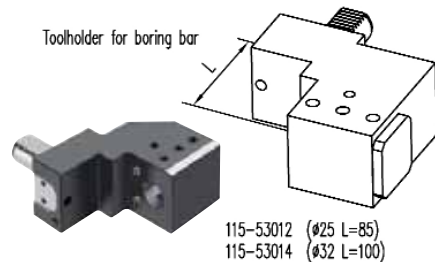

Toolholder for boring bar

115-53012 (Ø25 L=85)
 115-53014 (Ø32 L=100)



Toolholder for boring bar and collet chuck

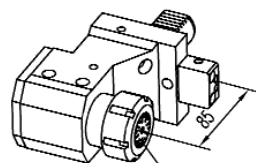

115-53001 (Ø32/ER32)

Cylindrical collet chuck 264-35185

Toolholder for boring bar and collet chuck

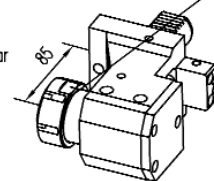

115-53010 (Ø32/ER32)

GILDEMEISTER (VDI40)

CTX410 V3 (option)
 CTX510 V3/V4
 CTX420 V3 (option)
 CTX520 V3/V4
 CTX Beta 500/800/1250 V3/V4
 CTX Gamma 1250/2000 V3/V4 (option)

AXIAL TURRET

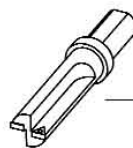
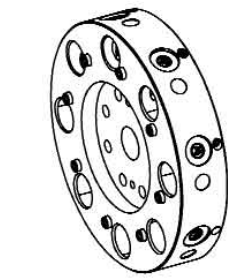
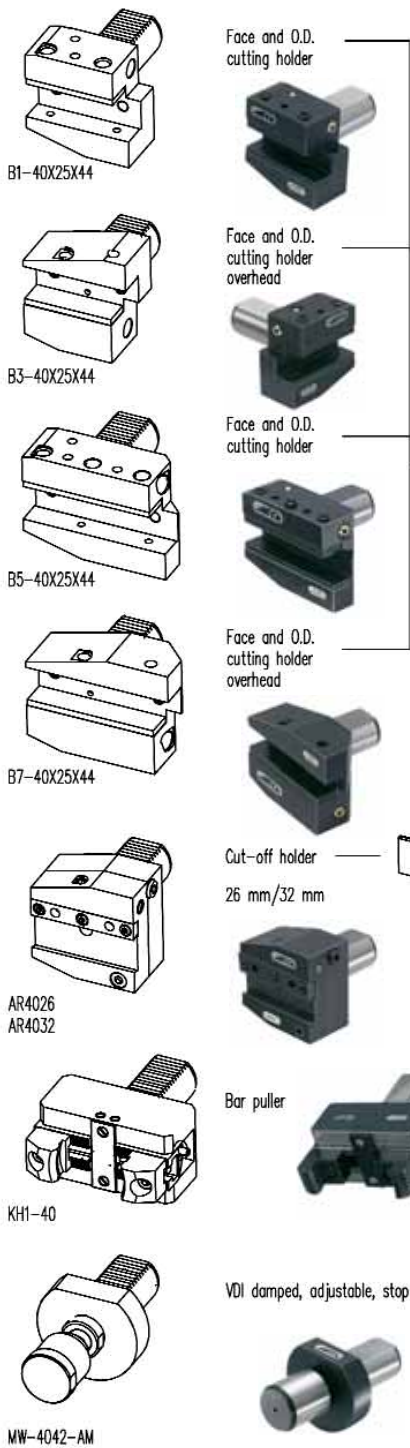

ACCESSORIES



Boring bar sleeve $\varnothing 25$ mm

- 115-62579 ($\varnothing 8$ mm)
- 115-62580 ($\varnothing 10$ mm)
- 115-62581 ($\varnothing 12$ mm)
- 115-62582 ($\varnothing 16$ mm)
- 115-62583 ($\varnothing 20$ mm)

Boring bar sleeve $\varnothing 32$ mm

- 165-63223 ($\varnothing 8$ mm)
- 165-63224 ($\varnothing 10$ mm)
- 165-63225 ($\varnothing 12$ mm)
- 165-63226 ($\varnothing 16$ mm)
- 165-63227 ($\varnothing 20$ mm)
- 165-63228 ($\varnothing 25$ mm)

Boring bar sleeve $\varnothing 40$ mm

- 165-64082 ($\varnothing 8$ mm)
- 165-64083 ($\varnothing 10$ mm)
- 165-64084 ($\varnothing 12$ mm)
- 165-64085 ($\varnothing 16$ mm)
- 165-64086 ($\varnothing 20$ mm)
- 165-64087 ($\varnothing 25$ mm)
- 165-64088 ($\varnothing 32$ mm)

Toolholder for insert drill

- E1-40x06WN ($\varnothing 6$ mm)
- E1-40x08WN ($\varnothing 8$ mm)
- E1-40x10WN ($\varnothing 10$ mm)
- E1-40x12WN ($\varnothing 12$ mm)
- E1-40x16 ($\varnothing 16$ mm)
- E1-40x20 ($\varnothing 20$ mm)
- E1-40x25 ($\varnothing 25$ mm)
- E1-40x32 ($\varnothing 32$ mm)
- E1-40x40 ($\varnothing 40$ mm)
- E1-40x50 ($\varnothing 50$ mm)



Toolholder for boring bar

- E2-40x6 ($\varnothing 6$ mm)
- E2-40x8 ($\varnothing 8$ mm)
- E2-40x10 ($\varnothing 10$ mm)
- E2-40x12 ($\varnothing 12$ mm)
- E2-40x16 ($\varnothing 16$ mm)
- E2-40x20 ($\varnothing 20$ mm)
- E2-40x25 ($\varnothing 25$ mm)
- E2-40x32 ($\varnothing 32$ mm)
- E2-40x40 ($\varnothing 40$ mm)
- E2-40x50 ($\varnothing 50$ mm)



Double holder for boring bar

- E7-40x32 ($\varnothing 32$ mm)



Toolholder for boring bar

- 118-04013 (HSK63A+C)



Collet chuck

- E4-40x20 (ER20)
- E4-40x25 (ER25)
- E4-40x32 (ER32)
- E4-40x40 (ER40)

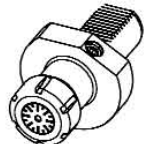

Drilling chuck

- KS2-40-13 ($\varnothing 1$ - $\varnothing 13$ mm)
- KS2-40-16 ($\varnothing 3$ - $\varnothing 16$ mm)

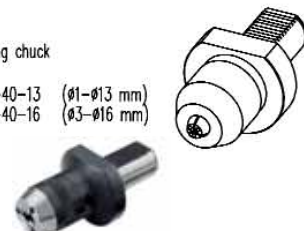

GILDEMEISTER (VDI40)

CTX410 V4/V6 (option) - CTX420 V4/V6
 CTXBeta 500/800/1250 V6
 TWIN42/65/102 RG2 - GMX250/300/400/500
 SPRINT65 (option)

RADIAL TURRET

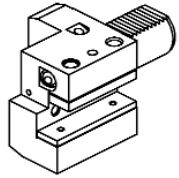

C1-40x25x85

Face and O.D. cutting holder

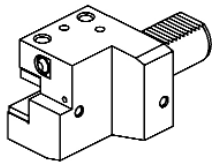

C2-40x25x85

Face and O.D. cutting holder

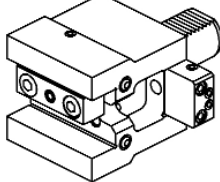

111-14035

Face and O.D. cutting holder

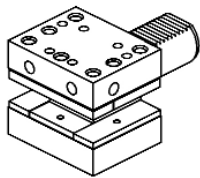

D1-40x25

Face and O.D. cutting holder

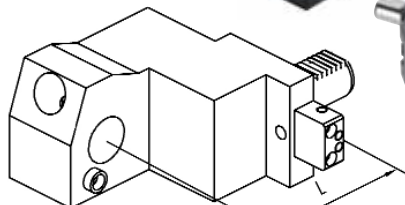

115-54139 (L=100)
 115-54141 (L=120)

Single site, right

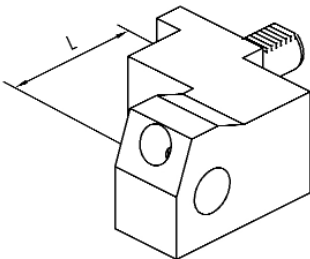

115-54140 (L=100)
 115-54142 (L=120)

Single site, left

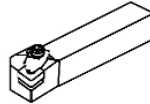
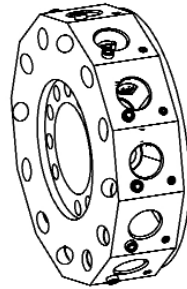

Qualified tool
 25x25 mm

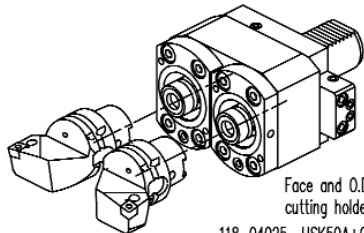

Face and O.D. cutting holder
 118-04025 HSK50A+C

Face and O.D. cutting holder

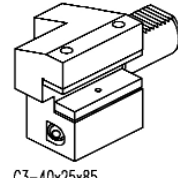

C3-40x25x85

Face and O.D. cutting holder

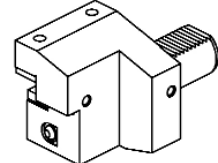

C4-40x25x85

Face and O.D. cutting holder

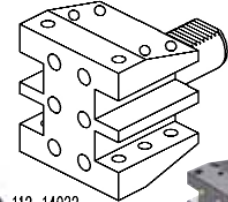

112-14022

Cut-off holder
 32 mm

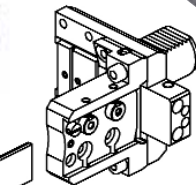
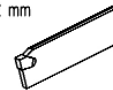

117-54006

VDI40/VDI40 ADAPTORS

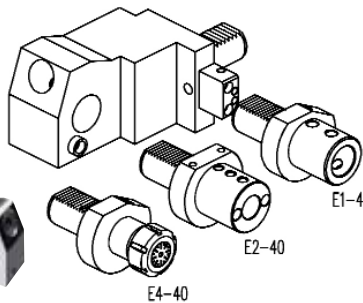

E1-40

E2-40

E4-40

Single site, right
 115-54143 (L=100)
 115-54145 (L=120)



Single site, left
 115-54144 (L=100)
 115-54146 (L=120)

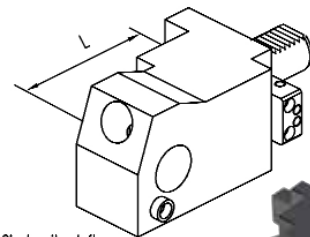

GILDEMEISTER (VDI40)

CTX410 V4/V6 (option) - CTX420 V4/V6
 CTXBeta 500/800/1250 V4/V6
 TWIN42/65/102 RG2 - GMX250/300/400/500
 SPRINT65 (option)

RADIAL TURRET

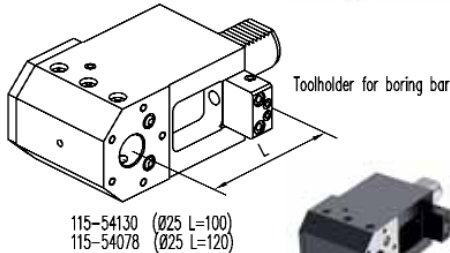
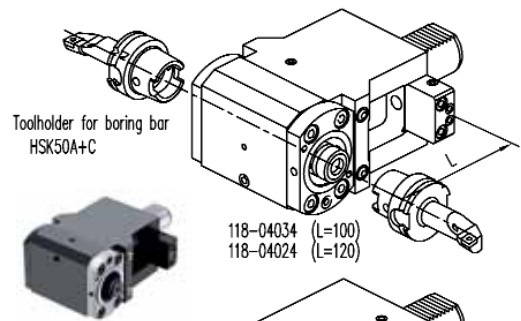
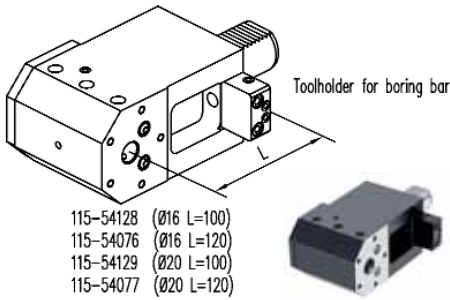
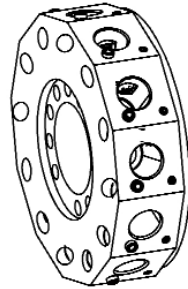

ACCESSORIES

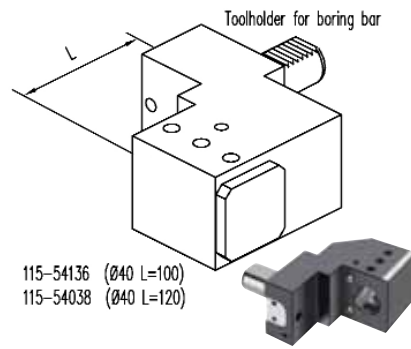
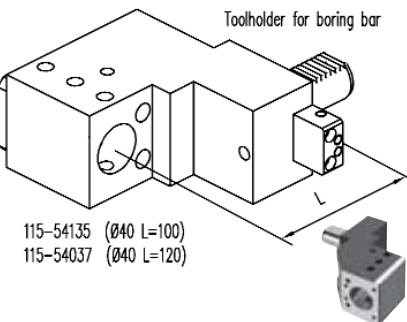
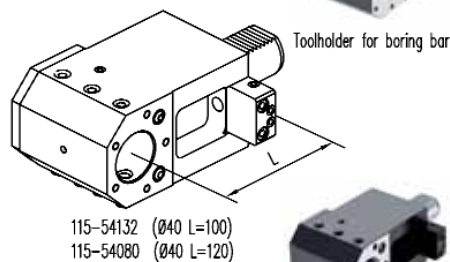
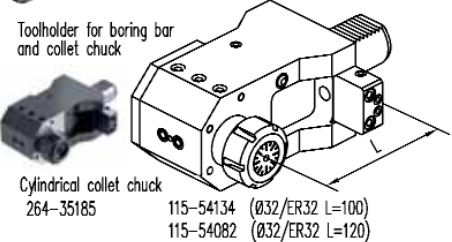
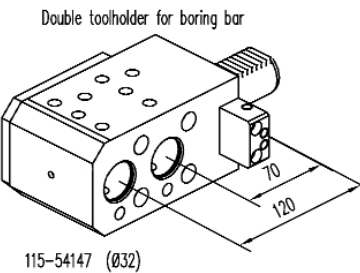
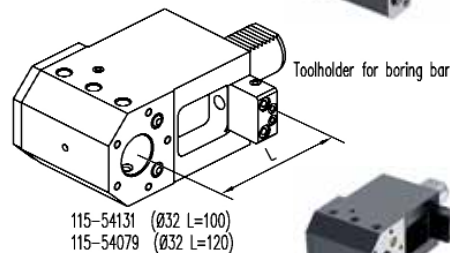
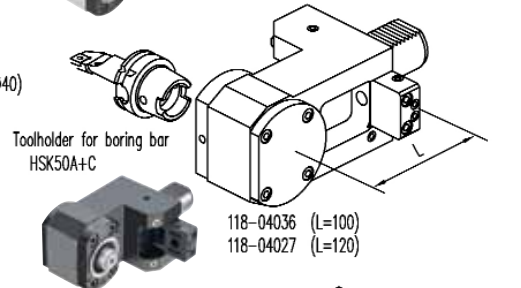
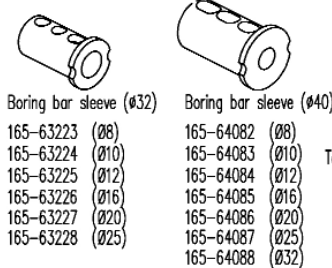
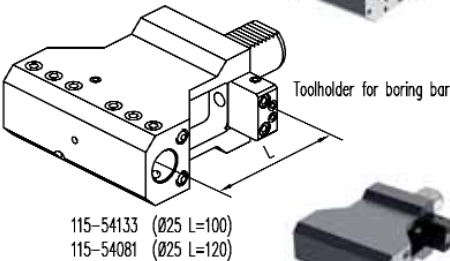
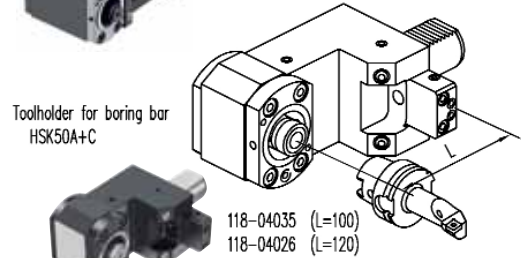
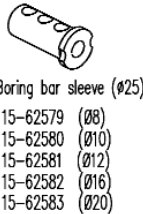

GILDEMEISTER (VDI50)

CTX620 V3/V4/V1
CTX Gamma 1250/2000 V3/V4
CTV400

AXIAL TURRET

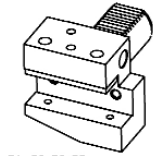

B1-50x32x55

Face and O.D.
cutting holder

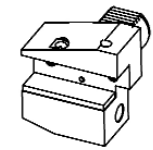

B3-50x32x55

Face and O.D.
cutting holder
overhead

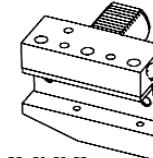

B5-50x32x55

Face and O.D.
cutting holder

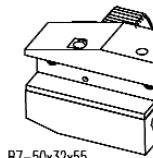

B7-50x32x55

Face and O.D.
cutting holder
overhead

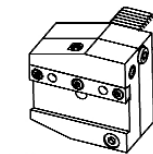

AR5026
AR5032

Cut-off holder
26 mm/32 mm

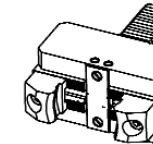

KH1-50

Bar puller

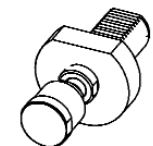

MW-5042-AM

VDI damped, adjustable, stop bar

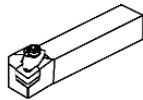
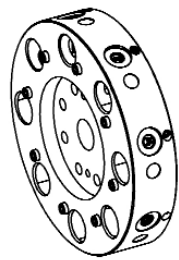

Qualified tool
32x32 mm

ACCESSORIES



E2-115

Boring bar sleeve $\varnothing 25$ mm

- 115-62584 ($\varnothing 8$ mm)
- 115-62585 ($\varnothing 10$ mm)
- 115-62586 ($\varnothing 12$ mm)
- 115-62587 ($\varnothing 16$ mm)
- 115-62588 ($\varnothing 20$ mm)

Boring bar sleeve $\varnothing 32$ mm

- 165-63229 ($\varnothing 8$ mm)
- 165-63230 ($\varnothing 10$ mm)
- 165-63231 ($\varnothing 12$ mm)
- 165-63232 ($\varnothing 16$ mm)
- 165-63233 ($\varnothing 20$ mm)
- 165-63234 ($\varnothing 25$ mm)

Boring bar sleeve $\varnothing 40$ mm

- 165-64082 ($\varnothing 8$ mm)
- 165-64083 ($\varnothing 10$ mm)
- 165-64084 ($\varnothing 12$ mm)
- 165-64085 ($\varnothing 16$ mm)
- 165-64086 ($\varnothing 20$ mm)
- 165-64087 ($\varnothing 25$ mm)
- 165-64088 ($\varnothing 32$ mm)

Toolholder for insert drill

- E1-50x16 ($\varnothing 16$ mm)
- E1-50x20 ($\varnothing 20$ mm)
- E1-50x25 ($\varnothing 25$ mm)
- E1-50x32 ($\varnothing 32$ mm)
- E1-50x40 ($\varnothing 40$ mm)
- E1-50x50 ($\varnothing 50$ mm)

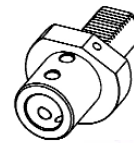

Toolholder for boring bar

- E2-50x12 ($\varnothing 12$ mm)
- E2-50x16 ($\varnothing 16$ mm)
- E2-50x20 ($\varnothing 20$ mm)
- E2-50x25 ($\varnothing 25$ mm)
- E2-50x32 ($\varnothing 32$ mm)
- E2-50x40 ($\varnothing 40$ mm)
- E2-50x50 ($\varnothing 50$ mm)

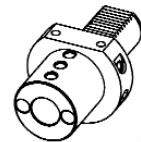

Double holder for boring bar

- E7-50x32 ($\varnothing 32$ mm L=50 mm)
- E7-50x50 ($\varnothing 50$ mm L=68 mm)

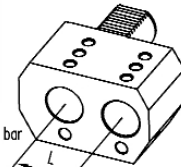

Toolholder for boring bar

118-05006 (HSK63A+C)



Collet chuck

- E4-50x25 (ER25)
- E4-50x32 (ER32)
- E4-50x40 (ER40)

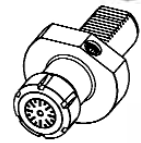

Drilling chuck

- KS2-50-13 ($\varnothing 1$ - $\varnothing 13$ mm)
- KS2-50-16 ($\varnothing 3$ - $\varnothing 16$ mm)

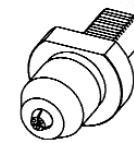

GILDEMEISTER GMX400 - GMX300 - GMX250 (HSK63T)

ATC Turret (HSK63T)

ICTM STANDARD

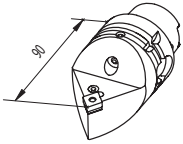

H63APCMNR12-90

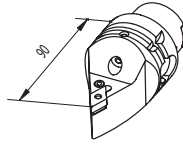

H63APDNNR15-90

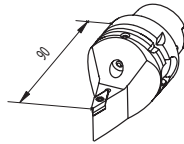

H63ASVVCN16-90

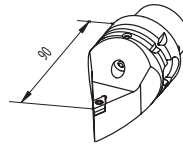

H63ASDNCN11-90

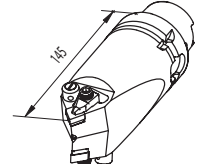

H63ADCM12DDM15-L145

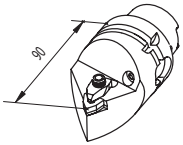

H63ADWMNR08-90

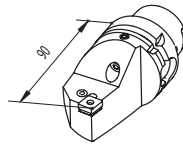

H63APCBNR12-90

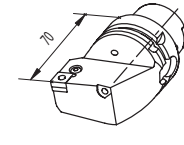

H63APCLNL/R12

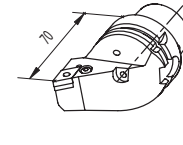

H63APDJNL/R15

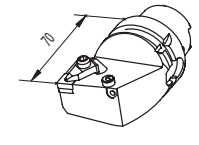

H63ADCLNL/R12

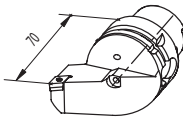

H63ASDJCL/R11

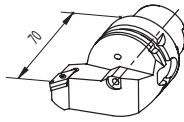

H63ASVJBL/R16

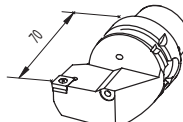

H63ASCLCL/R12

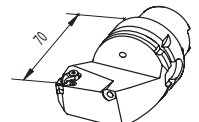

H63ATHEL/R16

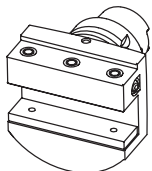

141-11408 32/25

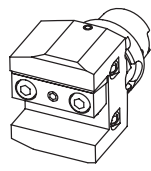

141-11406 25x25 mm

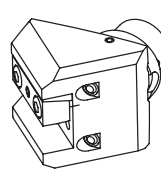

141-11405 25x25 mm

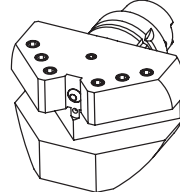

141-11409 25x25 mm

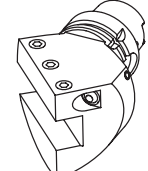

141-11407 (left) 25x25 mm
141-21401 (right)

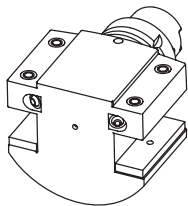

142-11405 32/25
142-11406 32/25

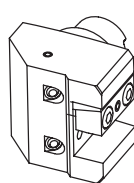

142-11402 25x25 mm

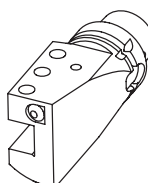

142-21401 (left) 25x25 mm
142-11403 (right)

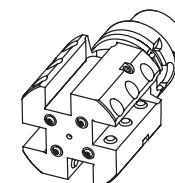

142-21404 20x20 mm (right)
142-21403 20x20 mm (left)

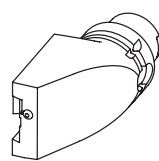

147-51405 (26mm, left)
147-51406 (26mm, right)
147-51407 (32mm, left)
147-51408 (32mm, right)

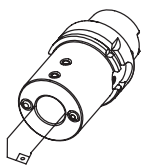

145-21404 (Ø12)
145-21406 (Ø16)
145-21408 (Ø20)
145-21409 (Ø25)
145-21410 (Ø32)
145-21411 (Ø40)

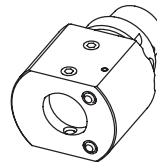

145-21412 Ø40 mm



165-64124 (Ø10 mm)
165-64125 (Ø12 mm)
165-64126 (Ø16 mm)
165-64127 (Ø20 mm)



165-64128 (Ø25 mm)
165-64129 (Ø32 mm)

GILDEMEISTER CTX510

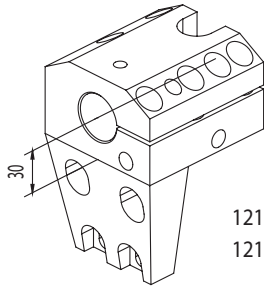

121-22551 Ø32H7
121-22566 Ø31.75H7(1.25")

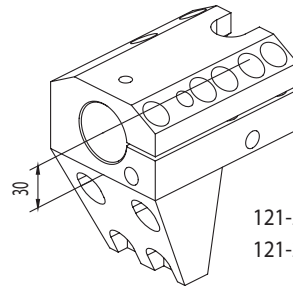

121-22552 Ø40H7
121-22567 Ø38.1H7(1.5")

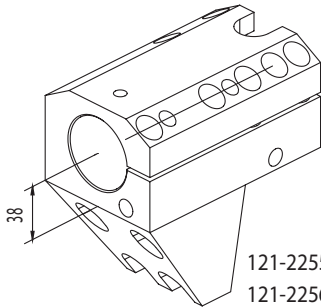

121-22558 Ø50H7
121-22564 Ø50.8H7(2")

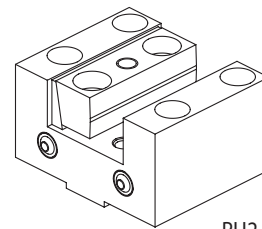

PU2-25-25

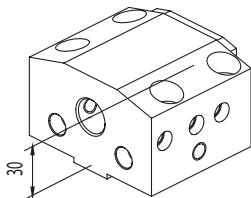

PU1-25-20 Ø20H7

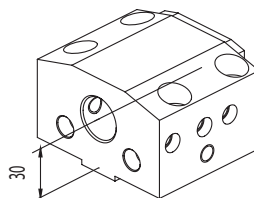

PU1-25-25 Ø25H7

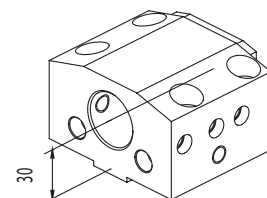

PU1-25-32 Ø32H7
PU1-25-1.25" Ø31.75H7

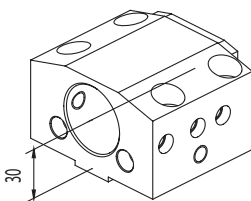

PU1-25-40 Ø40H7
PU1-25-1.5" Ø38.1H7

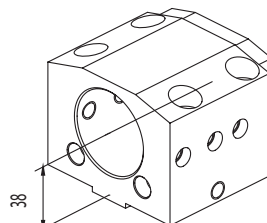

PU1-25-50 Ø50H7

GILDEMEISTER CXT620

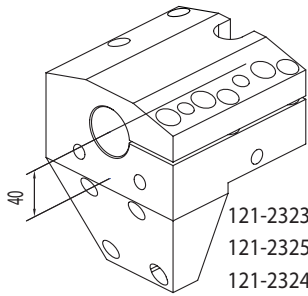

121-23239 Ø40H7
121-23253 Ø31,75H7(1,25")
121-23240 Ø38,1H7(1,5")

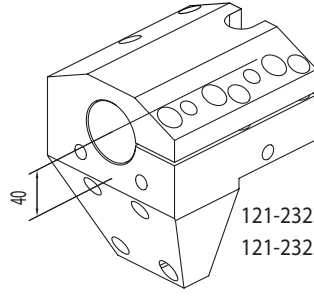

121-23236 Ø50H7
121-23250 Ø50,8H7(2")

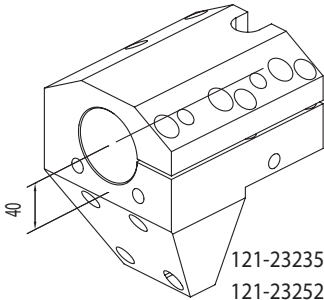

121-23235 Ø60H7
121-23252 Ø57,15H7(2,25")
121-23248 Ø63,5H7(2,5")

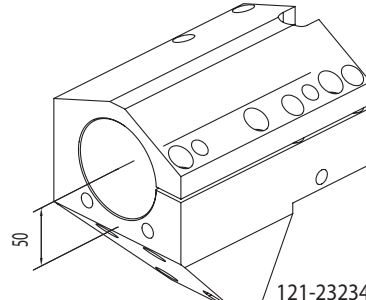

121-23234 Ø80H7
121-23254 Ø76,2H7(3")

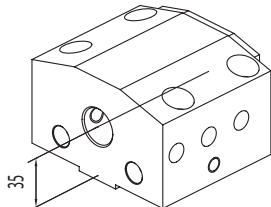

PU1-32-25 Ø25H7

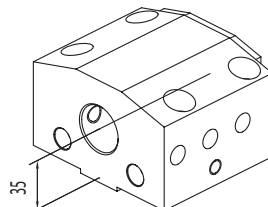

PU1-32-32 Ø32H7
PU1-32-1,25" Ø31,75H7

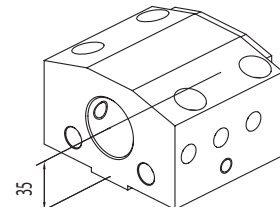

PU1-32-40 Ø40H7
PU1-32-1,5" Ø38,1H7

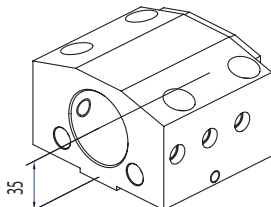

PU1-32-50 Ø50H7
PU1-32-2" Ø50,8H7

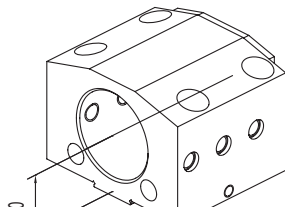

PU1-32-60 Ø60H7

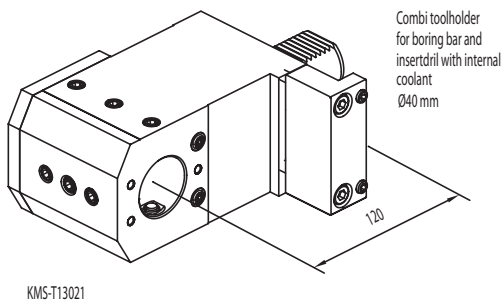
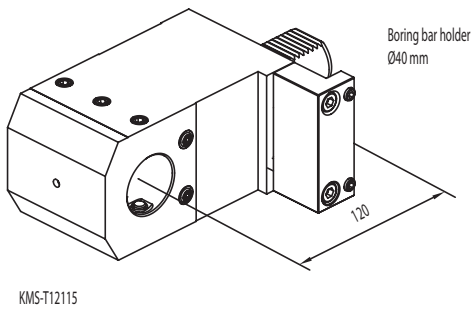
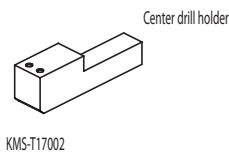
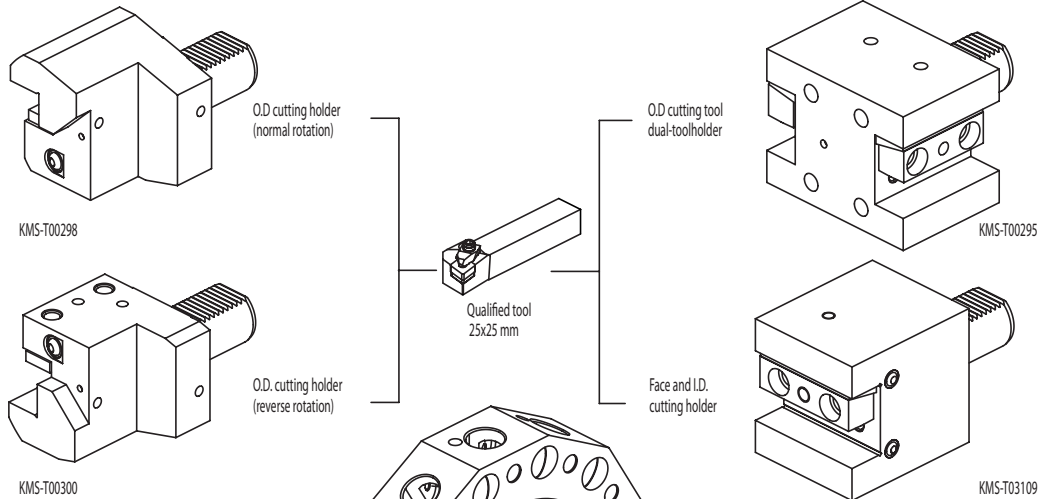

ACCESSORIES

Drill socket

- KMS-T22042 <MT3>
- KMS-T22046 <MT2>
- KMS-T22066 <MT1>

Boring bar sleeve

- KMS-T20098 (Ø32 mm)
- KMS-T20096 (Ø25 mm)
- KMS-T20094 (Ø20 mm)
- KMS-T20092 (Ø16 mm)
- KMS-T20090 (Ø12 mm)
- KMS-T20088 (Ø10 mm)
- KMS-T20086 (Ø8 mm)

Boring bar sleeve with internal coolant

- KMS-T20098-A (Ø32 mm)
- KMS-T20096-A (Ø25 mm)
- KMS-T20094-A (Ø20 mm)
- KMS-T20092-A (Ø16 mm)
- KMS-T20090-A (Ø12 mm)
- KMS-T20088-A (Ø10 mm)
- KMS-T20086-A (Ø8 mm)

KMS-T20196-A (Ø20 mm)

- KMS-T20194-A (Ø16 mm)
- KMS-T20110-A (Ø12 mm)
- KMS-T20108-A (Ø10 mm)
- KMS-T20106-A (Ø8 mm)

Drill socket with internal coolant

- KMS-T22042-A (MT3)
- KMS-T22044-A (MT4)
- KMS-T22046-A (MT2)
- KMS-T22066-A (MT1)

Throw-away drill socket

- KMS-T20100 (Ø32 mm)
- KMS-T20102 (Ø25 mm)
- KMS-T20104 (Ø20 mm)
- KMS-T20190 (Ø16 mm)

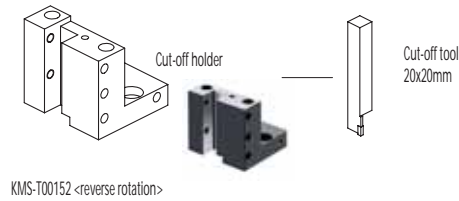
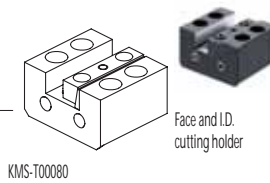
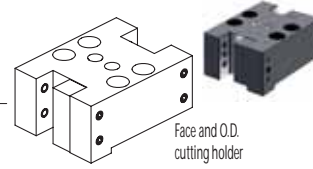
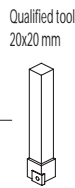
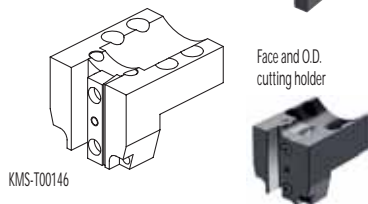
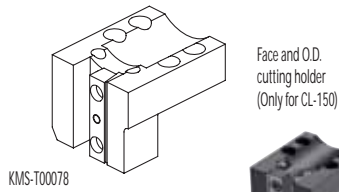
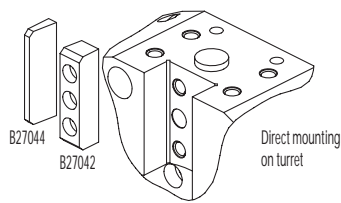

ACCESSORIES

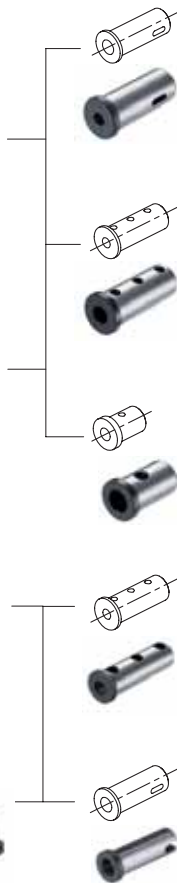
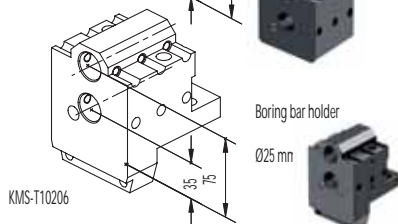
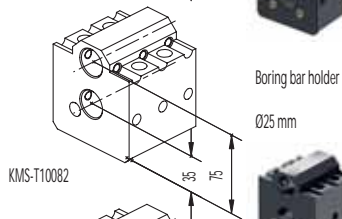
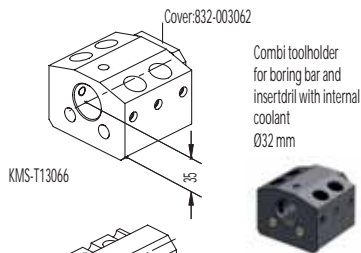
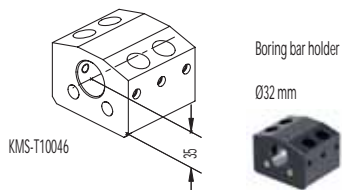

Drill socket

KMS-T22048 <MT2>
KMS-T22050 <MT1>

Boring bar sleeve

KMS-T20122 (Ø25 mm)
KMS-T20120 (Ø20 mm)
KMS-T20118 (Ø16 mm)
KMS-T20116 (Ø12 mm)
KMS-T20114 (Ø10 mm)
KMS-T20112 (Ø8 mm)

Throw-away drill socket

KMS-T22054 (Ø25 mm)
KMS-T22052 (Ø20 mm)
KMS-T22068 (Ø16 mm)

Boring bar sleeve

KMS-T20188 (Ø20 mm)
KMS-T20186 (Ø16 mm)
KMS-T20184 (Ø12 mm)
KMS-T20182 (Ø10 mm)
KMS-T20180 (Ø8 mm)

Drill socket

KMS-T22064 <MT2>
KMS-T22062 <MT1>

CONNECTION

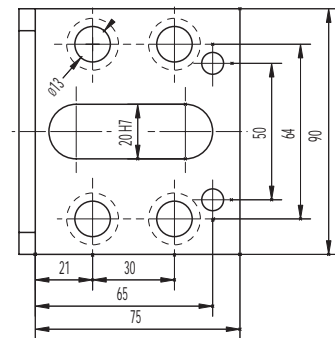

MORI SEIKI CMZ

SL153MC - ZL150MC - SL154MC TL15

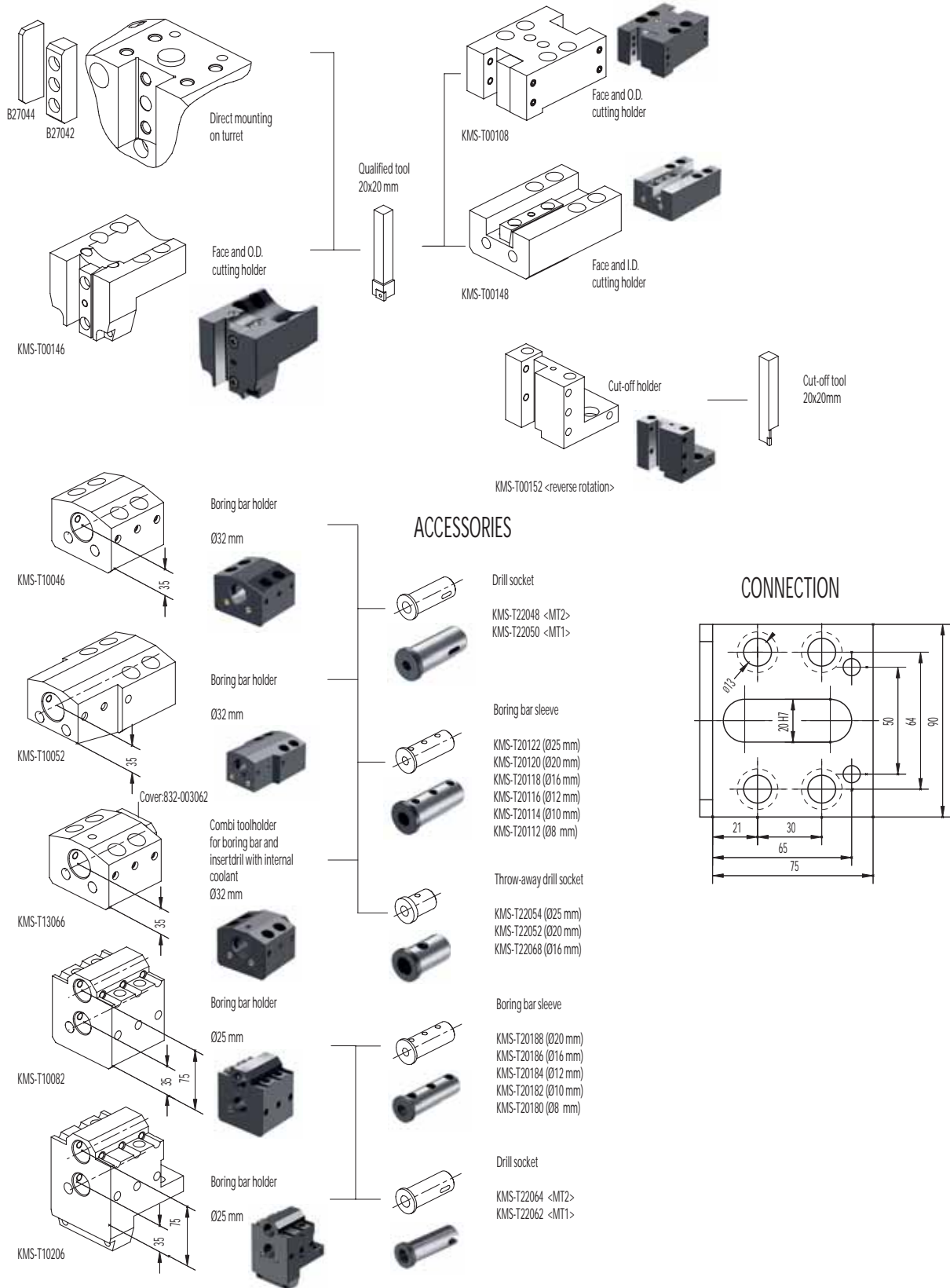

MORI SEIKI

SL200 - SL203 - SL250 - SL253 - ZL200 - ZL250
(CL200) - SL204 - DURATURN 2030
DURATURN 2050 - DURATURN 2550

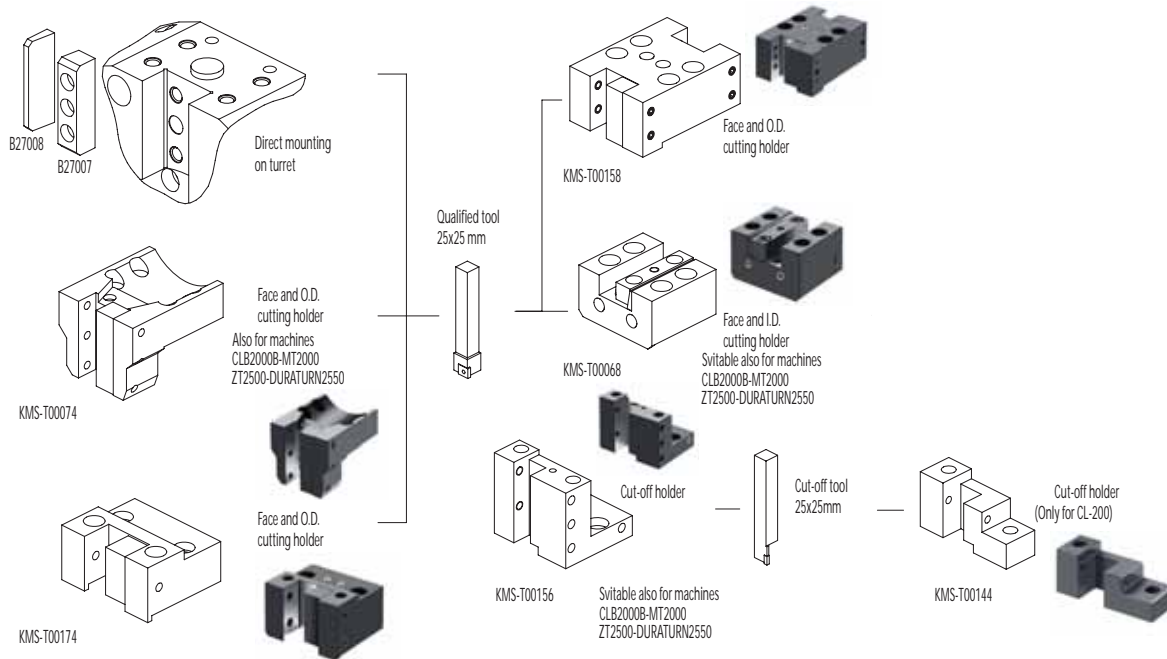

ACCESSORIES

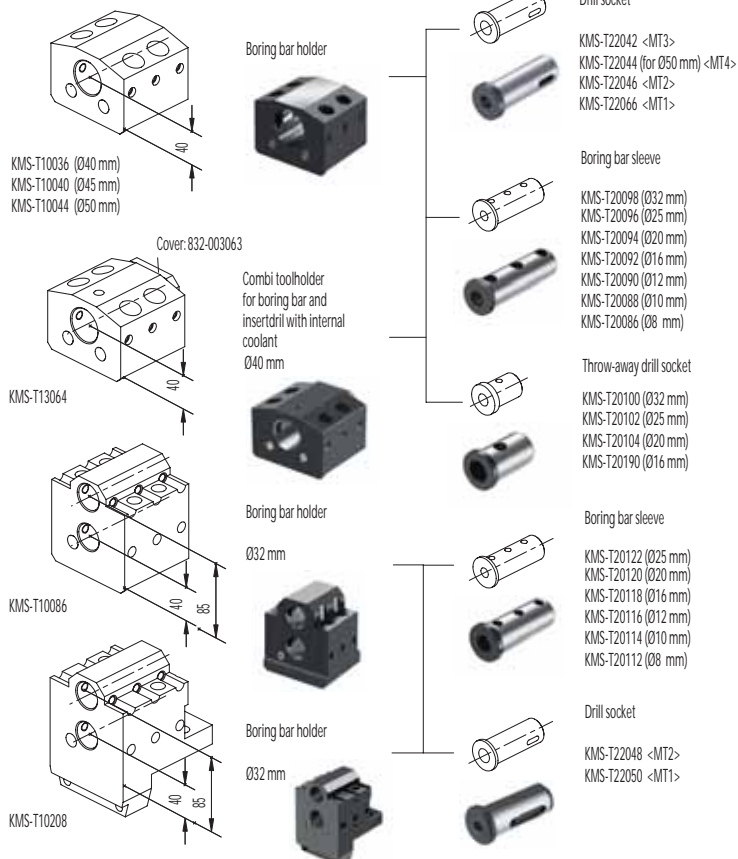

CONNECTION

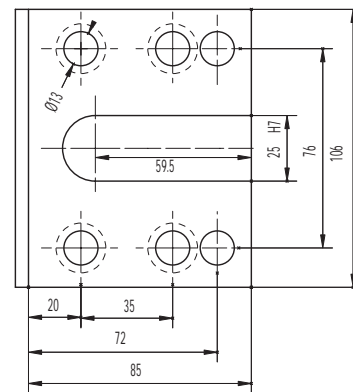

MORI SEIKI CMZ

SL203MC - SL253MC - ZL200MC
ZL250SMC - SL204SMC - SL300MC
TL20 - TL25 - TC30 - TC35

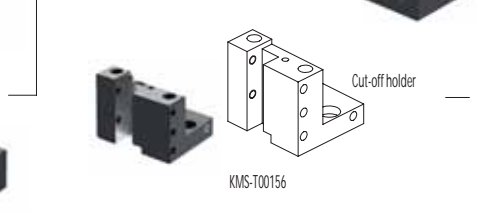
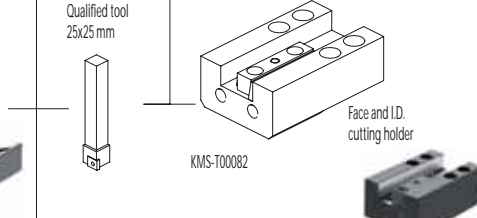
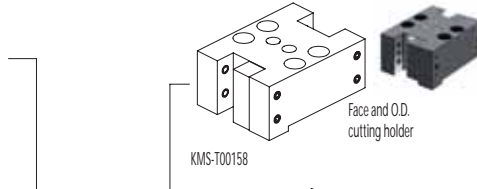
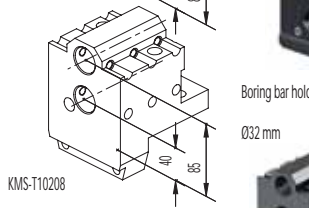
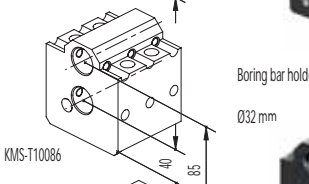
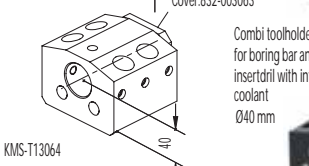
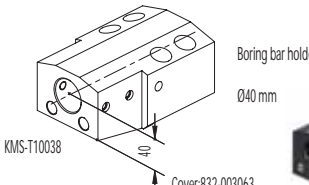
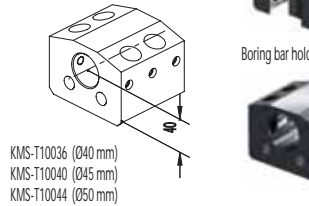
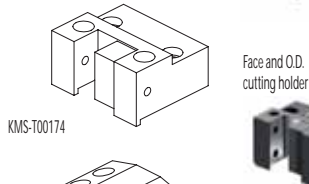
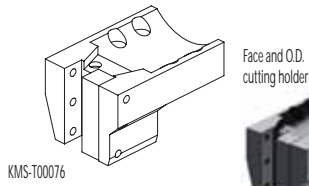
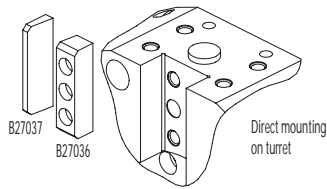

ACCESSORIES



CONNECTION

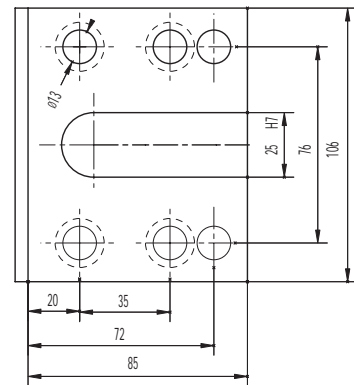

832-018722 (25 mm)
832-018732 (20 mm)
832-018721 (25 mm)
832-018731 (20 mm)

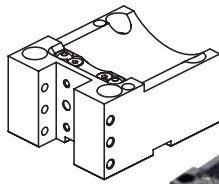

KMS-T00186 (25x25 mm)
KMS-T00187 (20x20 mm)

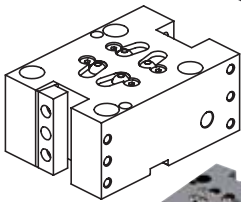

KMS-T00184 (25x25 mm)
KMS-T00185 (20x20 mm)

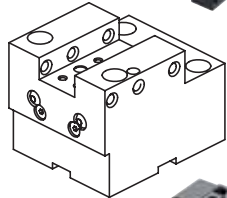

KMS-T03005 (25x25 mm)
KMS-T03006 (20x20 mm)

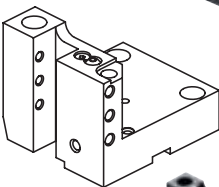

KMS-T00197 (25x25 mm)

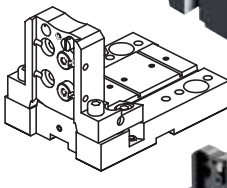

137-00092 (32 mm)

CONNECTION

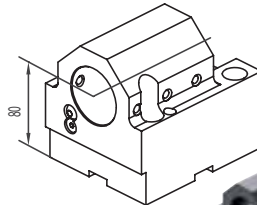
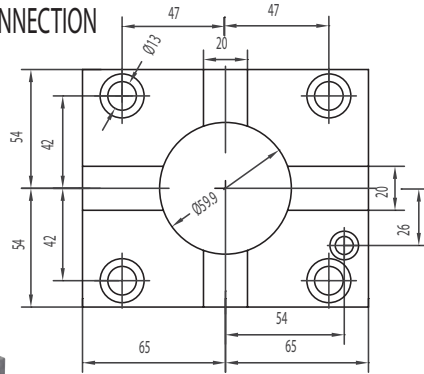

KMS-T10097 (Ø40 mm)
KMS-T10098 (Ø50 mm)

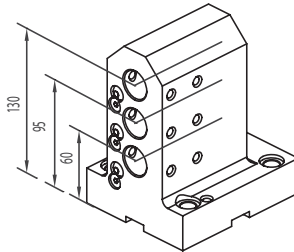

KMS-T10104 (Ø25 mm)

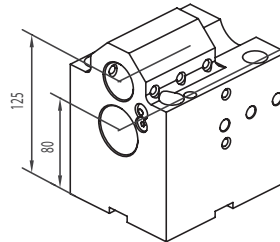

KMS-T10096 (Ø32 mm)

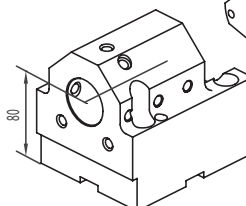

KMS-T13128 (Ø40 mm) with internal coolant

Driven tools

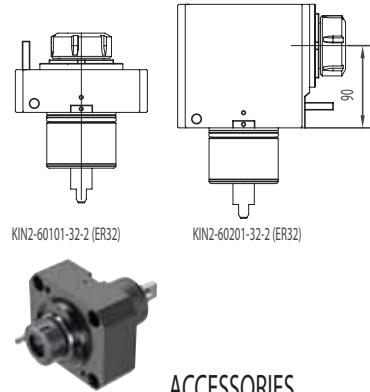

ACCESSORIES

KMS-T20098-A (Ø32 mm)
KMS-T20096-A (Ø25 mm)
KMS-T20094-A (Ø20 mm)
KMS-T20092-A (Ø16 mm)
KMS-T20090-A (Ø12 mm)
KMS-T20088-A (Ø10 mm)
KMS-T20086-A (Ø8 mm)

KMS-T20196-A (Ø20 mm)
KMS-T20194-A (Ø16 mm)
KMS-T20110-A (Ø12 mm)
KMS-T20108-A (Ø10 mm)
KMS-T20106-A (Ø8 mm)

KMS-T22042-A (MT3)
KMS-T22044-A (MT4)
KMS-T22046-A (MT2)
KMS-T22066-A (MT1)

KMS-T20188 (Ø20 mm)
KMS-T20186 (Ø16 mm)
KMS-T20184 (Ø12 mm)
KMS-T20182 (Ø10 mm)
KMS-T20180 (Ø8 mm)

KMS-T22064 (MT2)
KMS-T22062 (MT1)

KMS-T20122-A (Ø25 mm)
KMS-T20120-A (Ø20 mm)
KMS-T20118-A (Ø16 mm)
KMS-T20116-A (Ø12 mm)
KMS-T20114-A (Ø10 mm)
KMS-T20112-A (Ø8 mm)

KMS-T22048-A (MT2)
KMS-T22050-A (MT1)

KMS-T20100-A (Ø32 mm)
KMS-T20102-A (Ø25 mm)
KMS-T20104-A (Ø20 mm)
KMS-T20190-A (Ø16 mm)

KMS-T17002 (Ø25x25 mm)

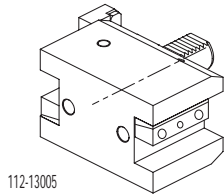

112-13005

Face and I.D.
cutting holder

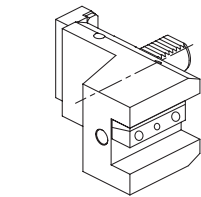

112-33008

Face and I.D.
cutting holder

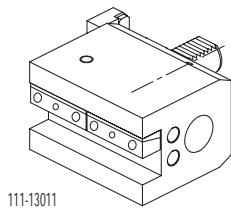

111-13011

Face and O.D.
cutting holder

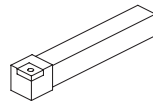

Qualified tool
20x20 mm

Cut-off holder
26 mm



117-53001

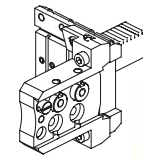

Boring bar holder

ACCESSORIES

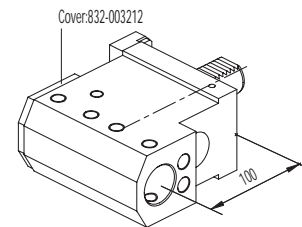

115-23045

Cover:832-003212

Combi toolholder
for boring bar and
insertdrill with internal
coolant

Ø32 mm

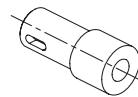

Drill socket

115-63282 <MT1>
115-63284 <MT2>

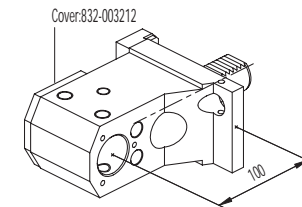

115-23046

Cover:832-003212

Combi toolholder
for boring bar and
insertdrill with internal
coolant

Ø32 mm

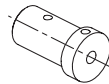

Boring bar sleeve

115-63286 (Ø8 mm)
115-63288 (Ø10 mm)
115-63290 (Ø12 mm)

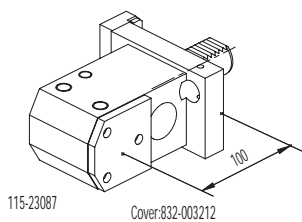

115-23087

Cover:832-003212

Combi toolholder
for boring bar and
insertdrill with internal
coolant

Ø32 mm

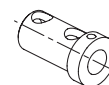

Boring bar sleeve

115-63292 (Ø16 mm)
115-63294 (Ø20 mm)
115-63296 (Ø25 mm)



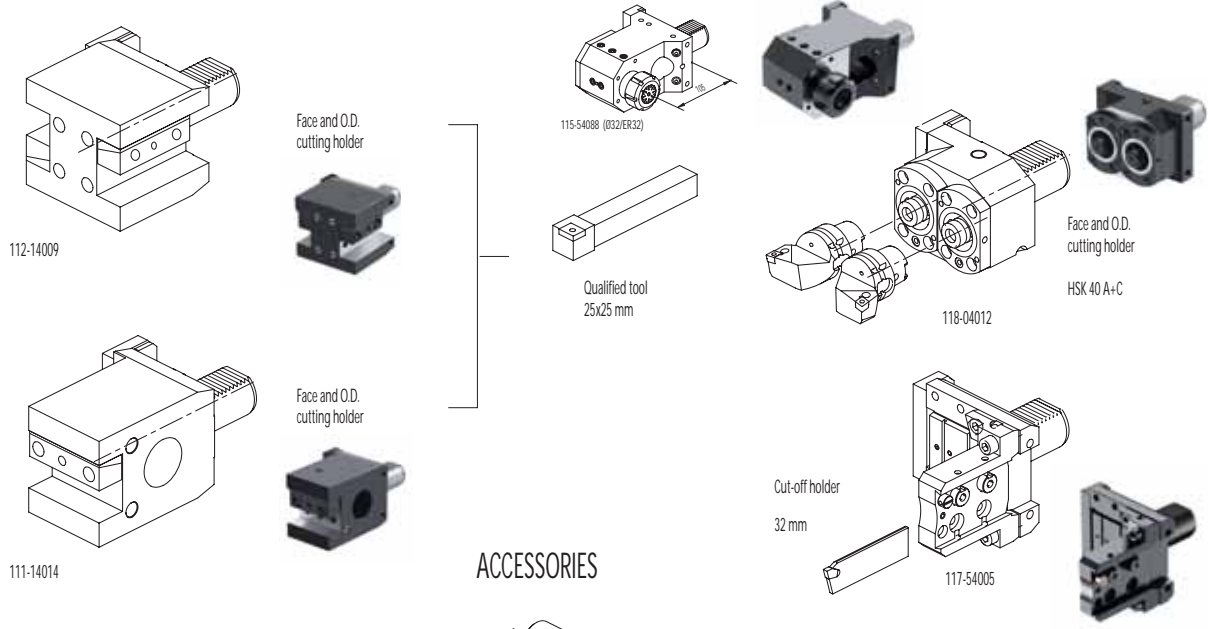

ACCESSORIES

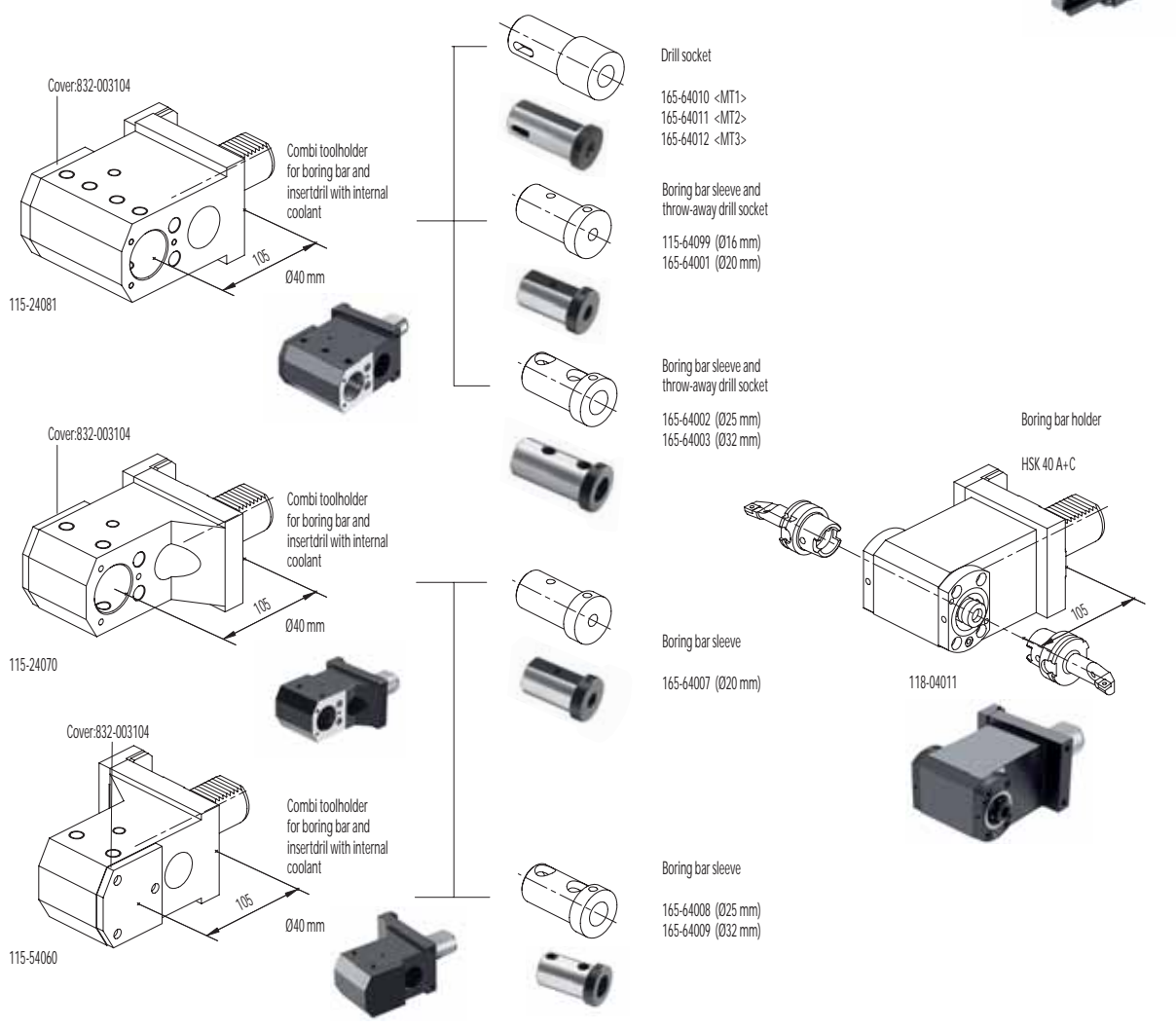

OKUMA LB15 - LB25
LB15II - LB300

HAAS SL20 - SL30

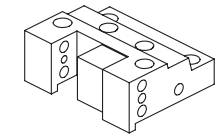

128-42011

Face and O.D.
cutting holder

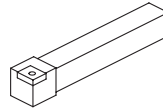

Qualified tool
25x25 mm

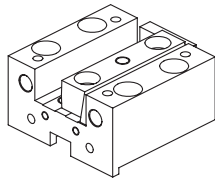

128-32001

Face and I.D.
cutting holder



CONNECTION

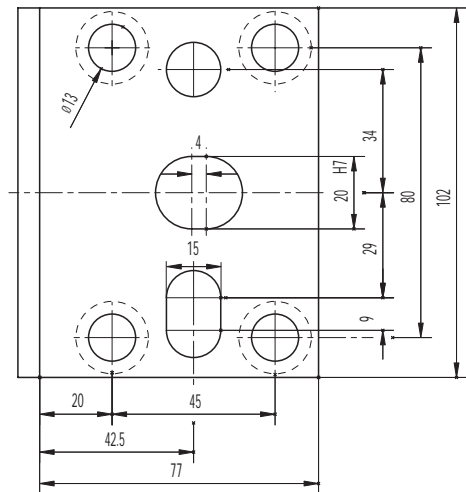

ACCESSORIES

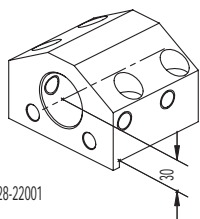

128-22001

Toolholder
for boring bar

Ø40 mm

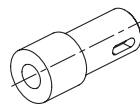

Drill socket

165-64010 <MT1>
165-64011 <MT2>
165-64012 <MT3>



Boring bar sleeve and
throw-away drill socket

165-64135 (Ø8 mm)
165-64013 (Ø10 mm)
165-64014 (Ø12 mm)
165-64015 (Ø16 mm)
165-64016 (Ø20 mm)

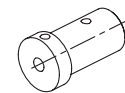

Boring bar sleeve and
throw-away drill socket

165-64017 (Ø25 mm)
165-64018 (Ø32 mm)

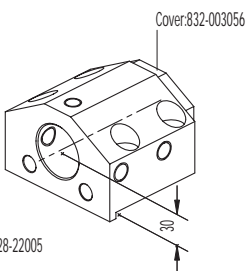

128-22005

Cover:832-003056

Combi toolholder
for boring bar and
insert drill with internal
coolant

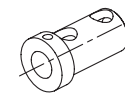

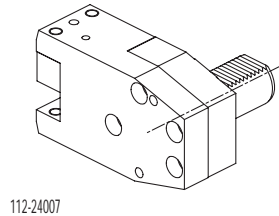

112-24007

Face and I.D.
cutting holder

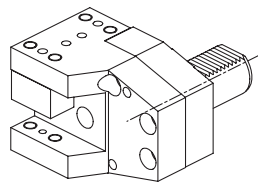

111-64005

Face and O.D.
cutting holder

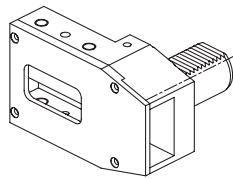

111-64006

Face and O.D.
cutting holder

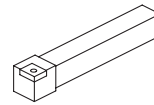

Qualified tool
25x25 mm

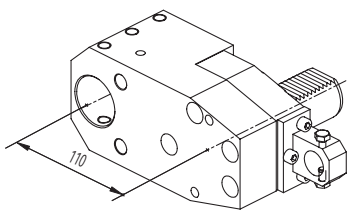

115-24068

Toolholder
for boring bar

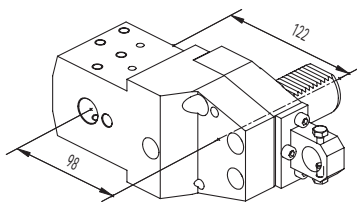

115-24067

Double toolholder
for boring bar



ACCESSORIES

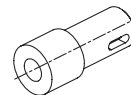

Drill socket

- 165-64010 <MT1>
- 165-64011 <MT2>
- 165-64012 <MT3>

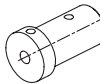

Boring bar sleeve

- 165-64024 (Ø10 mm)
- 165-64025 (Ø12 mm)
- 165-64026 (Ø16 mm)
- 165-64027 (Ø20 mm)

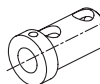

Boring bar sleeve

- 165-64028 (Ø25 mm)
- 165-64029 (Ø32 mm)



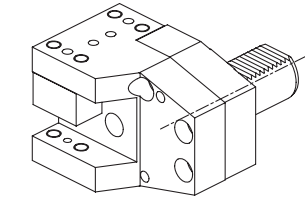

111-64009

Face and O.D.
cutting holder

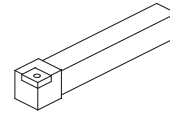

Qualified tool
25x25 mm

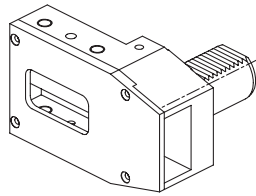

111-64006

Face and O.D.
cutting holder



ACCESSORIES

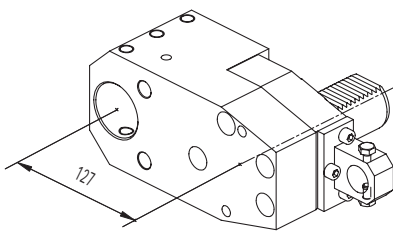

115-24093

Toolholder
for boring bar

Ø40 mm

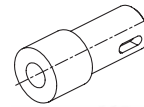

Drill socket

- 165-64010 <MT1>
- 165-64011 <MT2>
- 165-64012 <MT3>

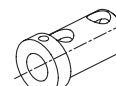

Boring bar sleeve

- 165-64028 (Ø25 mm)
- 165-64029 (Ø32 mm)



OKUMA (HSK63T)

Mac Turn 250/350/400 Multus B250/B300/B400

For turning

ATC Turret (HSK63T)

ICTM STANDARD

45°

90°

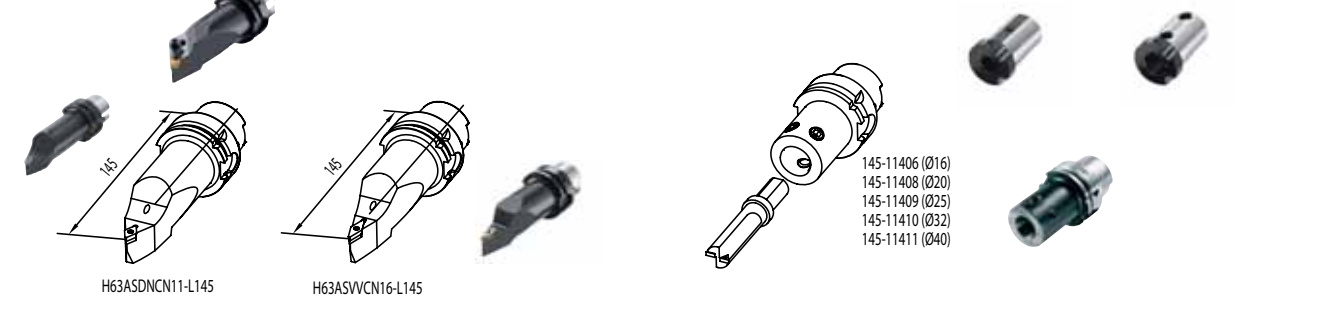
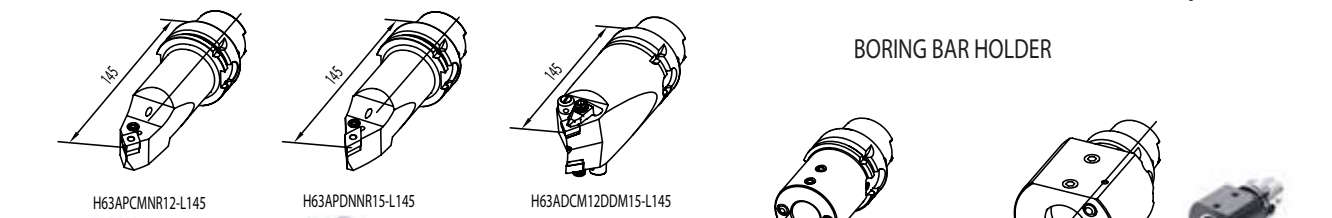
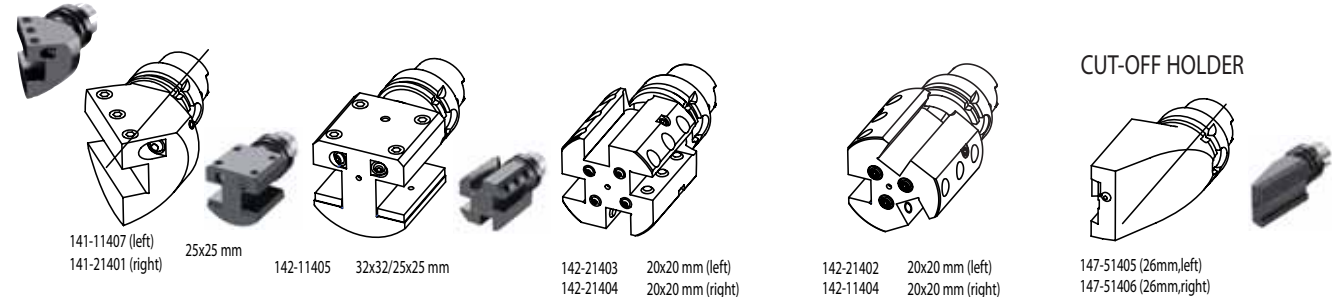
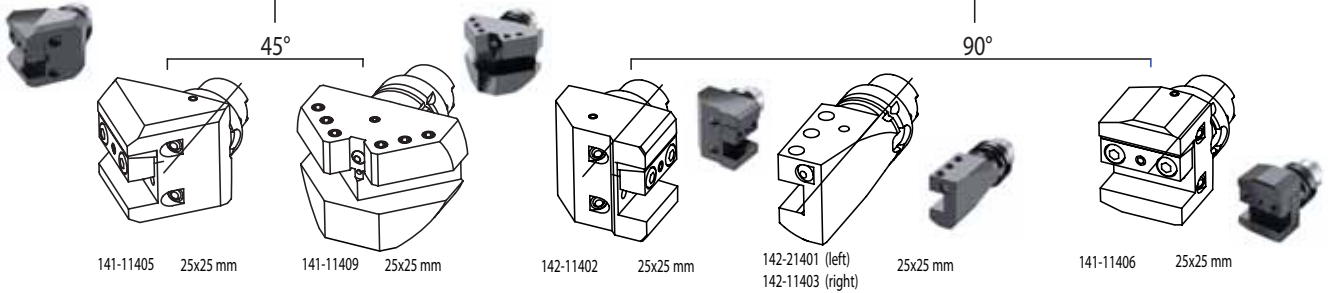

Lower Turret (VDI 40)

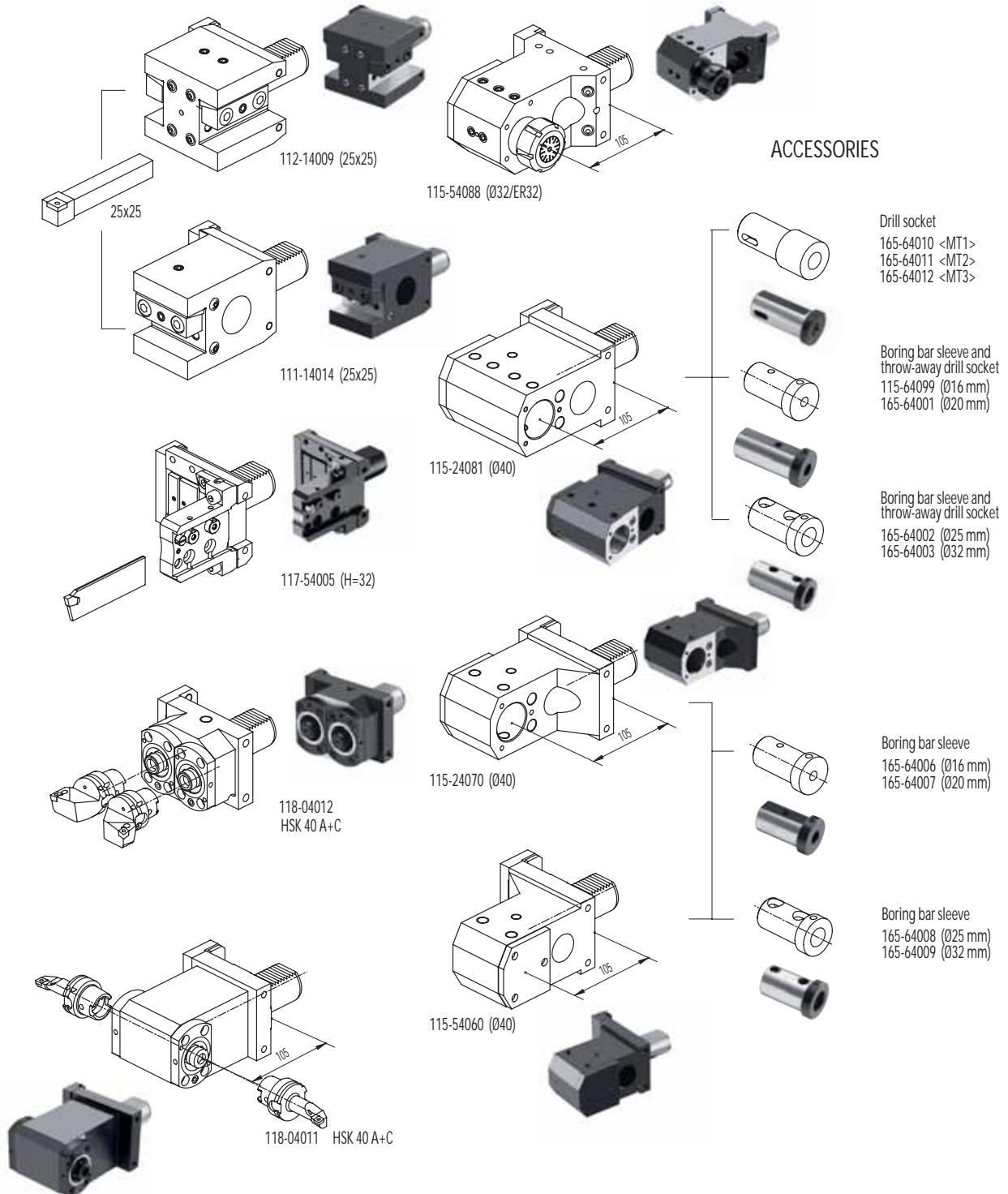

For turning

ATC Turret (HSK100A) ICTM STANDARD

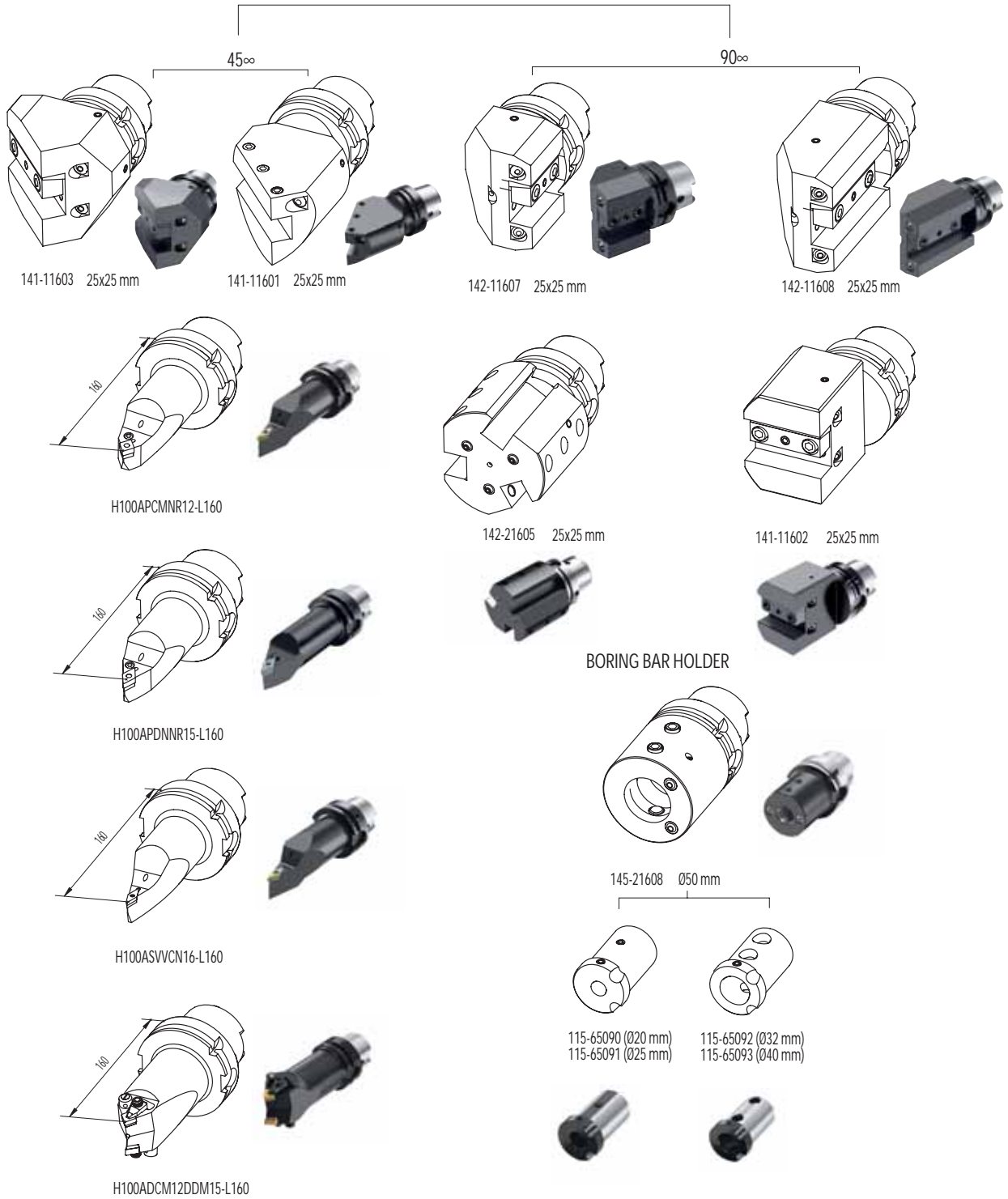

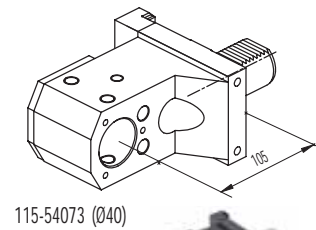
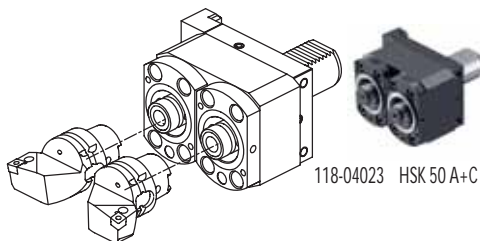
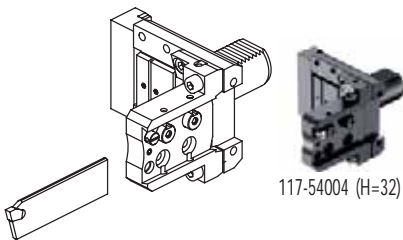
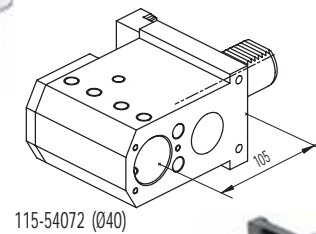
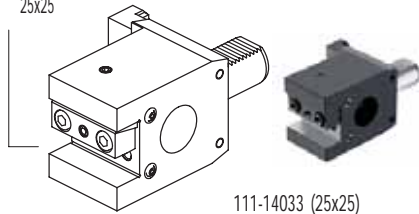
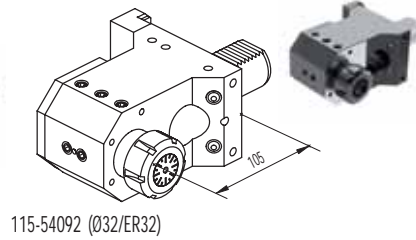
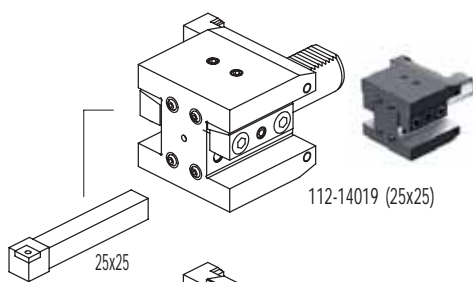

ACCESSORIES



Drill socket
165-64010 <MT1>
165-64011 <MT2>
165-64012 <MT3>



Boring bar sleeve and
throw-away drill socket
115-64099 (Ø16 mm)
165-64001 (Ø20 mm)

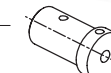

Boring bar sleeve and
throw-away drill socket
165-64002 (Ø25 mm)
165-64003 (Ø32 mm)



Boring bar sleeve
165-64124 (Ø10 mm)
165-64125 (Ø12 mm)
165-64126 (Ø16 mm)
165-64127 (Ø20 mm)



Boring bar sleeve
165-64008 (Ø25 mm)
165-64009 (Ø32 mm)



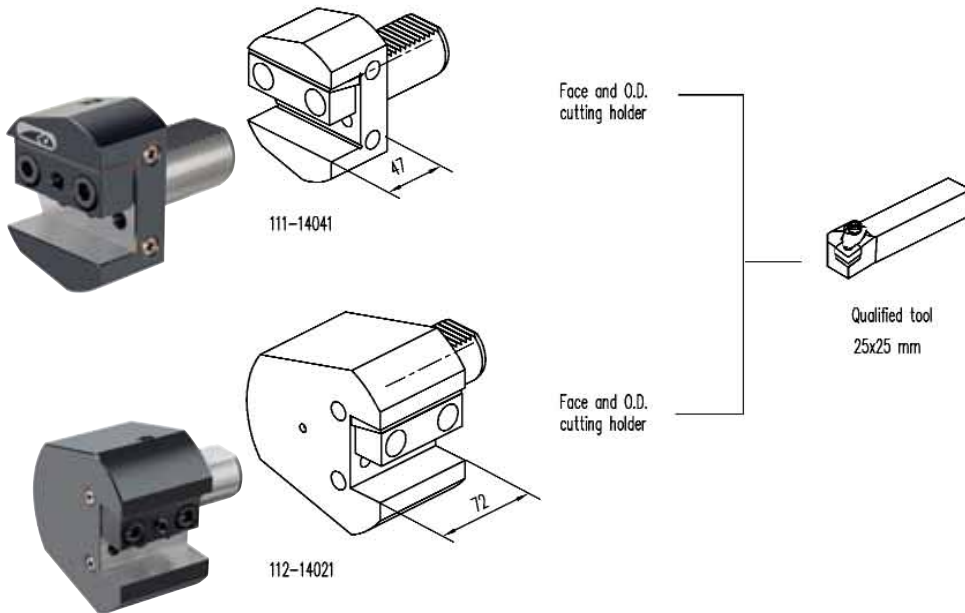

ACCESSORIES

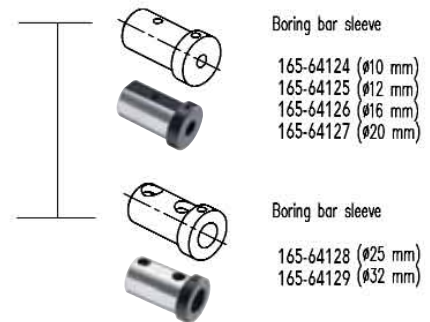
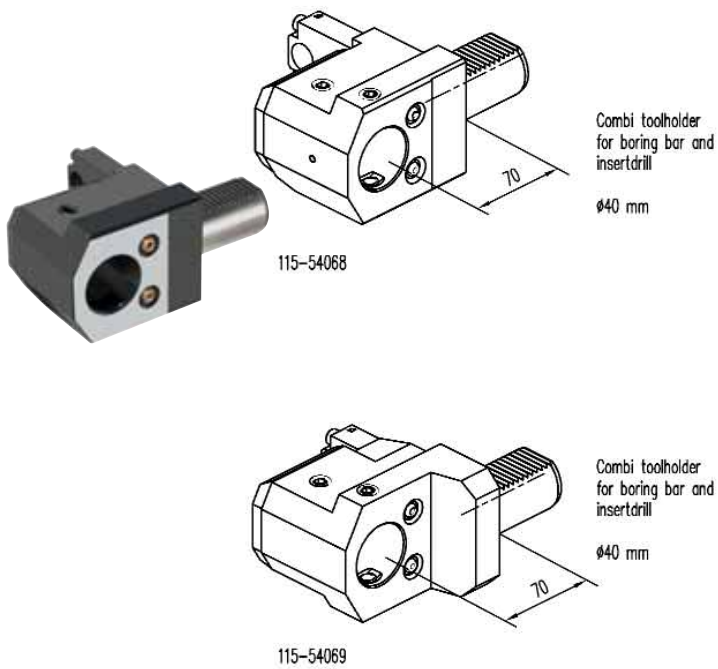

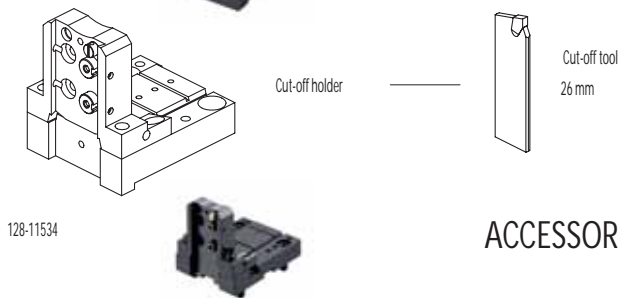
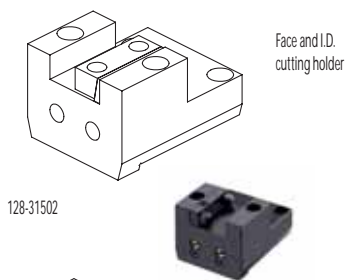
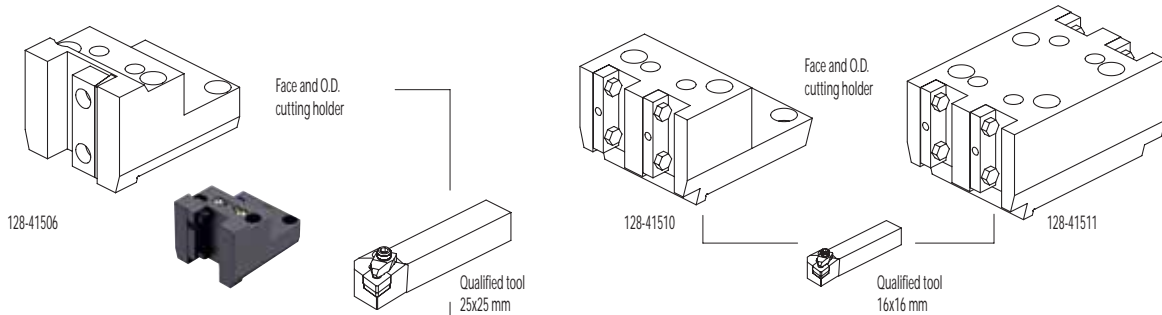

CONNECTION

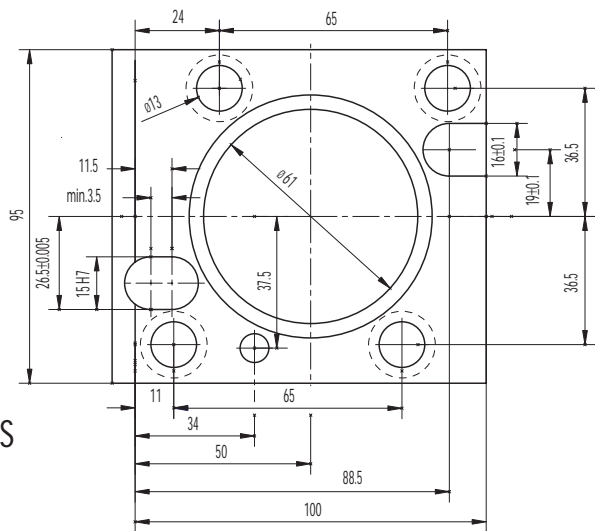

ACCESSORIES

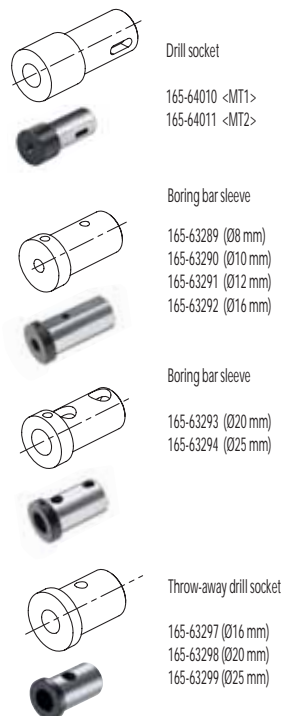
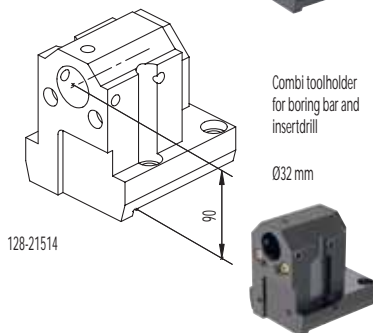
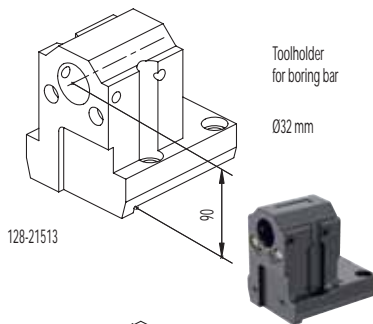

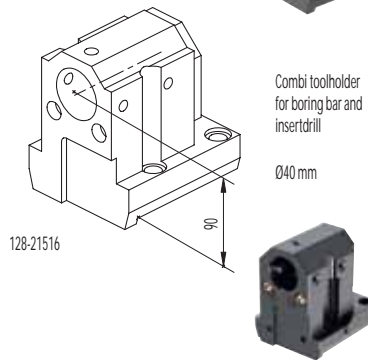
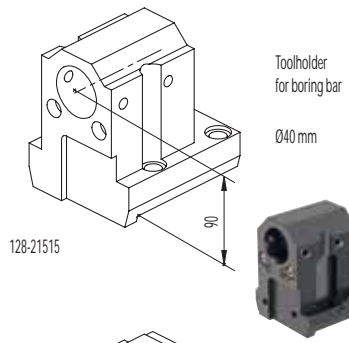
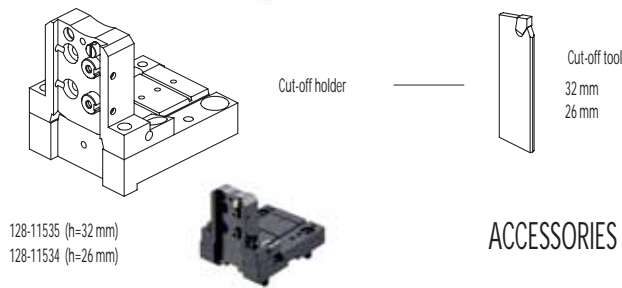
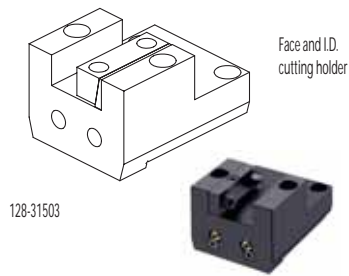
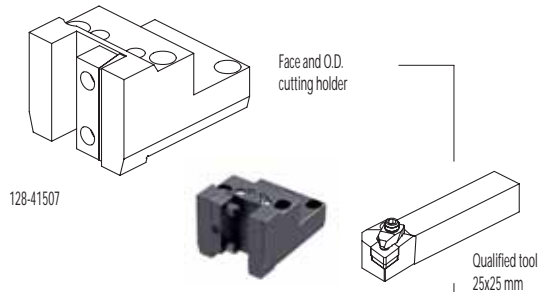

ACCESSORIES

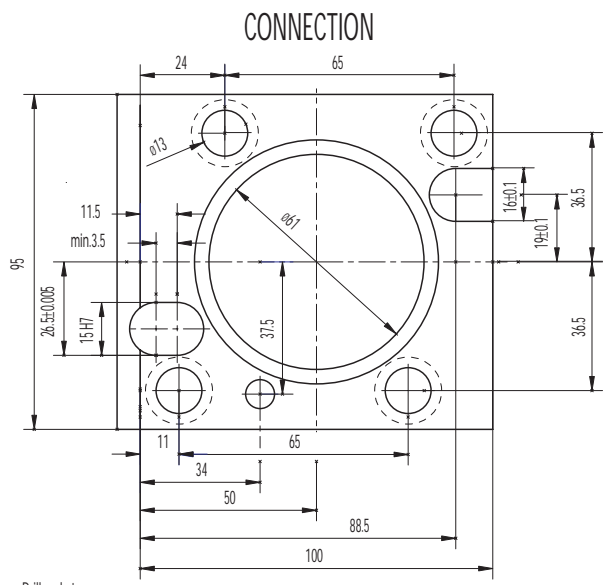
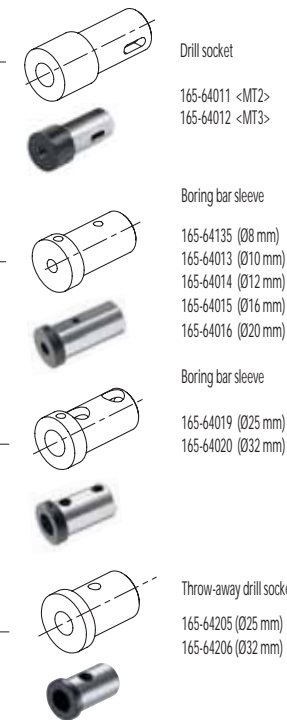

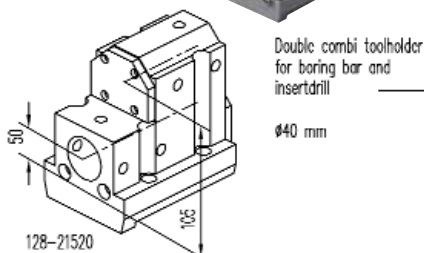
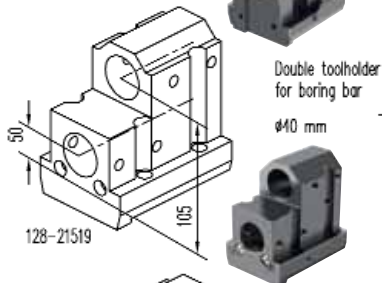
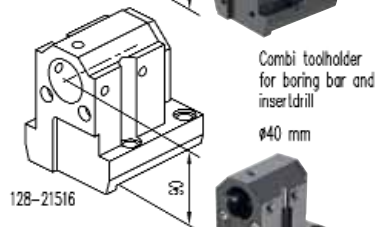
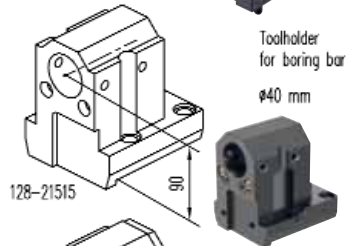
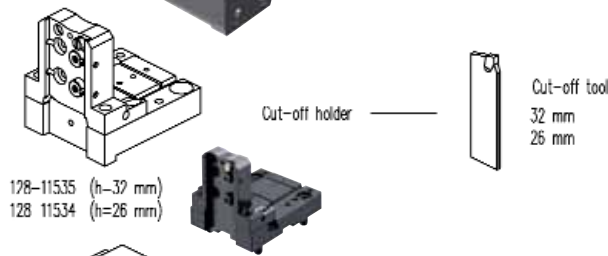
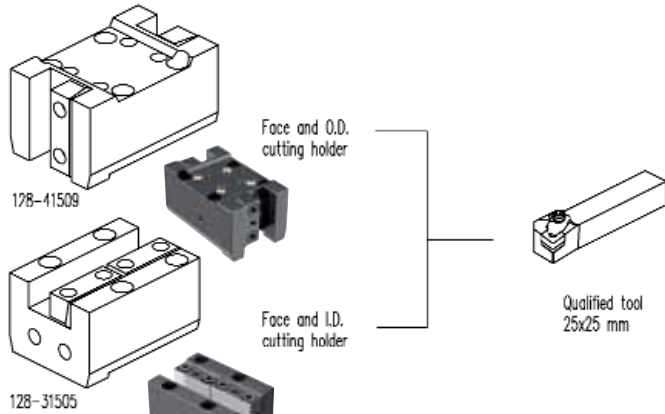

ACCESSORIES

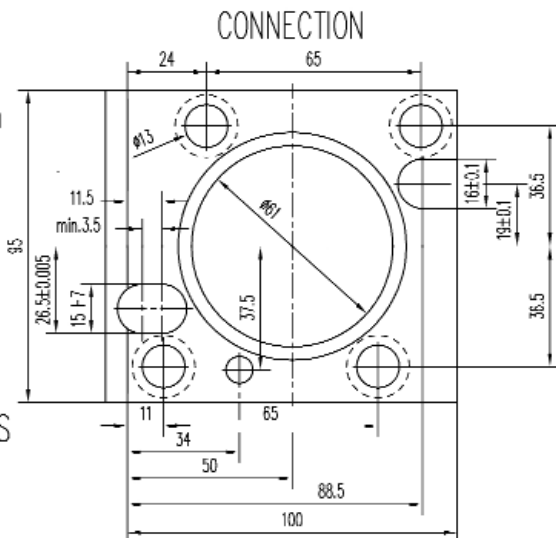
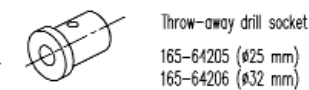
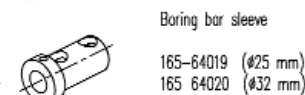
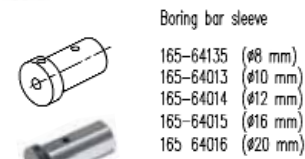
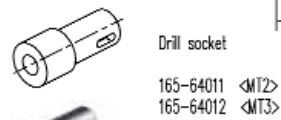

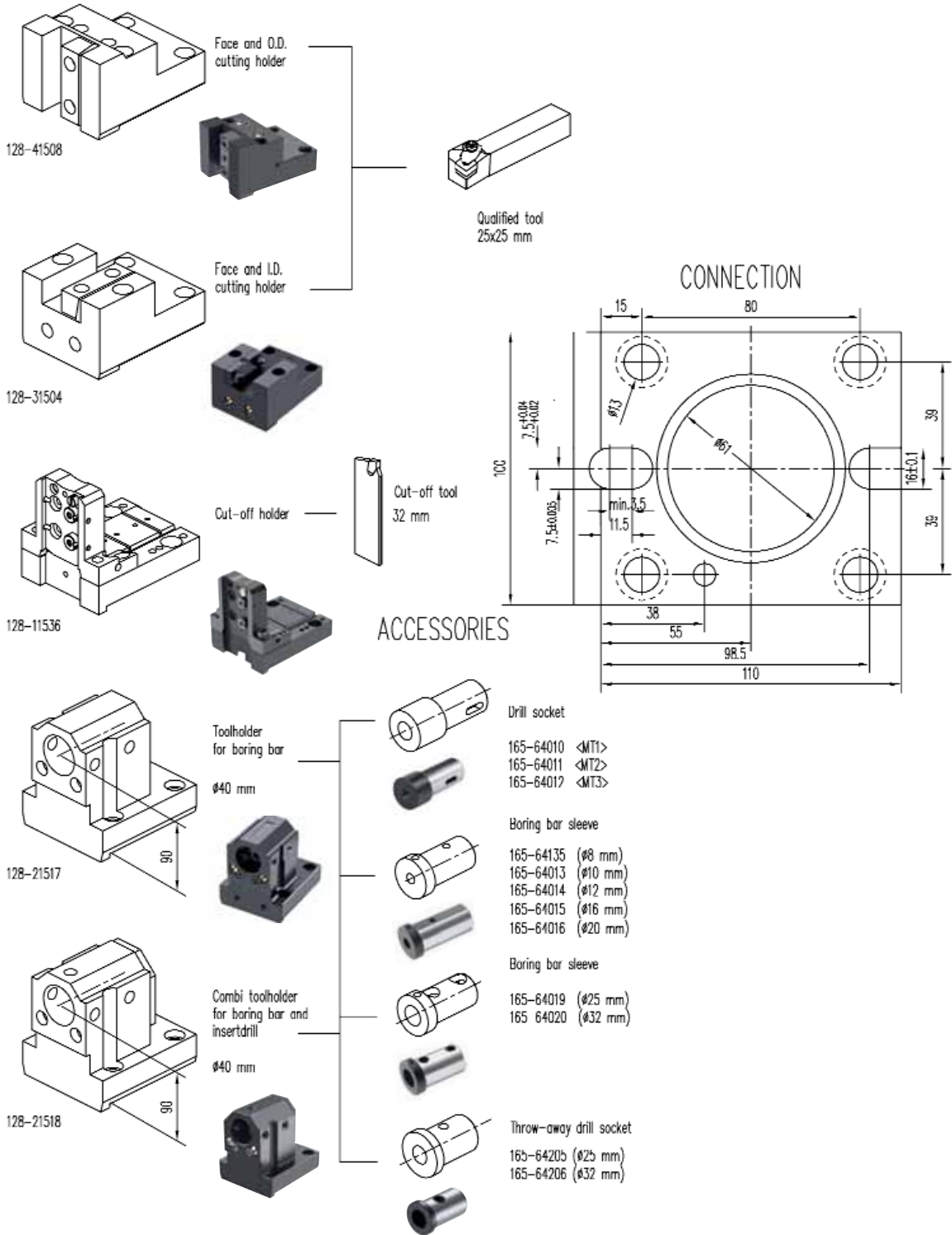

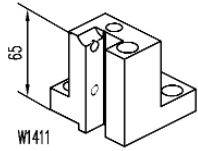

W1411

Face and O.D. cutting holder

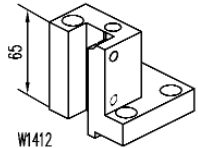

W1412

Face and O.D. cutting holder

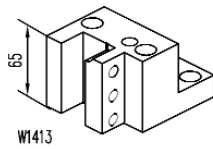

W1413

Face and O.D. cutting holder

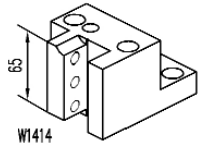

W1414

Face and O.D. cutting holder

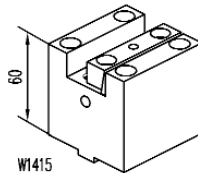

W1415

Face and I.D. cutting holder

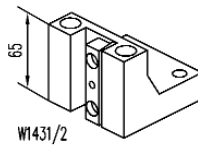

W1431/2

Face and O.D. cutting holder

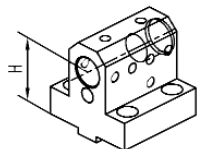

W1417 D25 (H=55 mm)
W4437 D25 (H=75 mm)

Combi toolholder for boring bar and insertdrill

∅25 mm

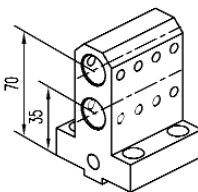

W1418 D25

Double toolholder for boring bar

∅25 mm

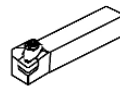

Qualified tool
20x20 mm

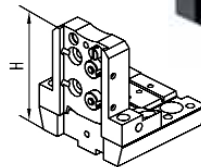

Cut-off holder



Cut-off tool

121-22075 (h=26 mm H=95 mm)
121-22076 (h=32 mm H=100 mm)

CONNECTION

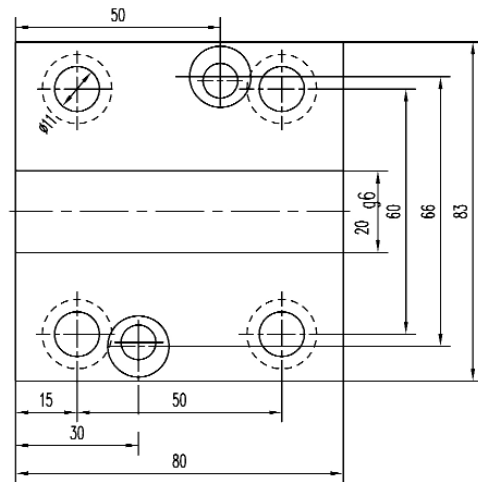

ACCESSORIES

Boring bar sleeve and throw-away drill socket

- 739.0125.020 TW10 (∅20 mm)
- 739.0125.016 TW10 (∅16 mm)
- 739.0125.012 TW10 (∅12 mm)
- 739.0125.010 TW10 (∅10 mm)
- 739.0125.008 TW10 (∅8 mm)
- 739.0125.006 TW10 (∅6 mm)

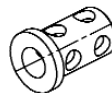

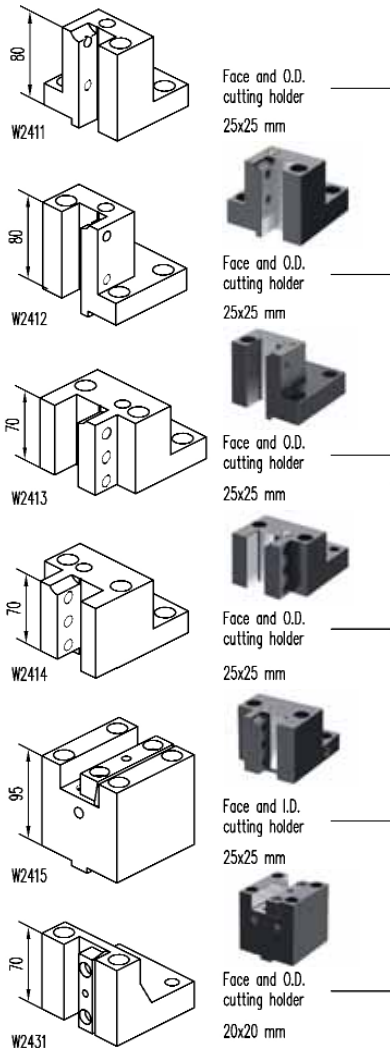

ACCESSORIES

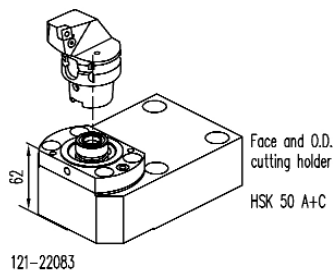
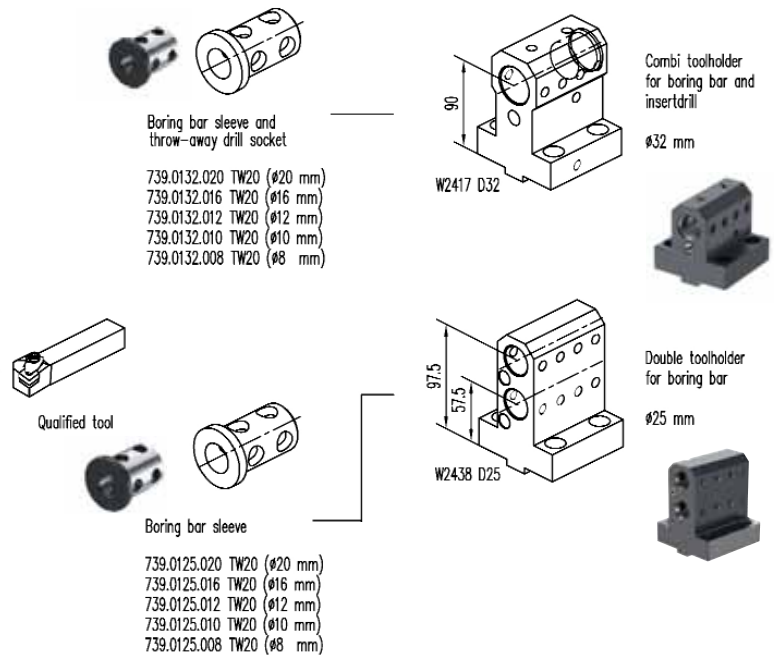

CONNECTION

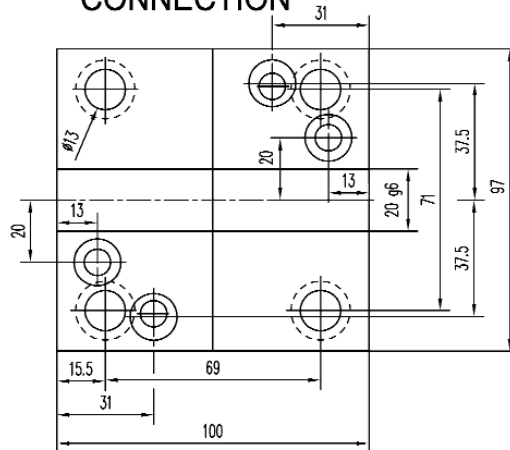

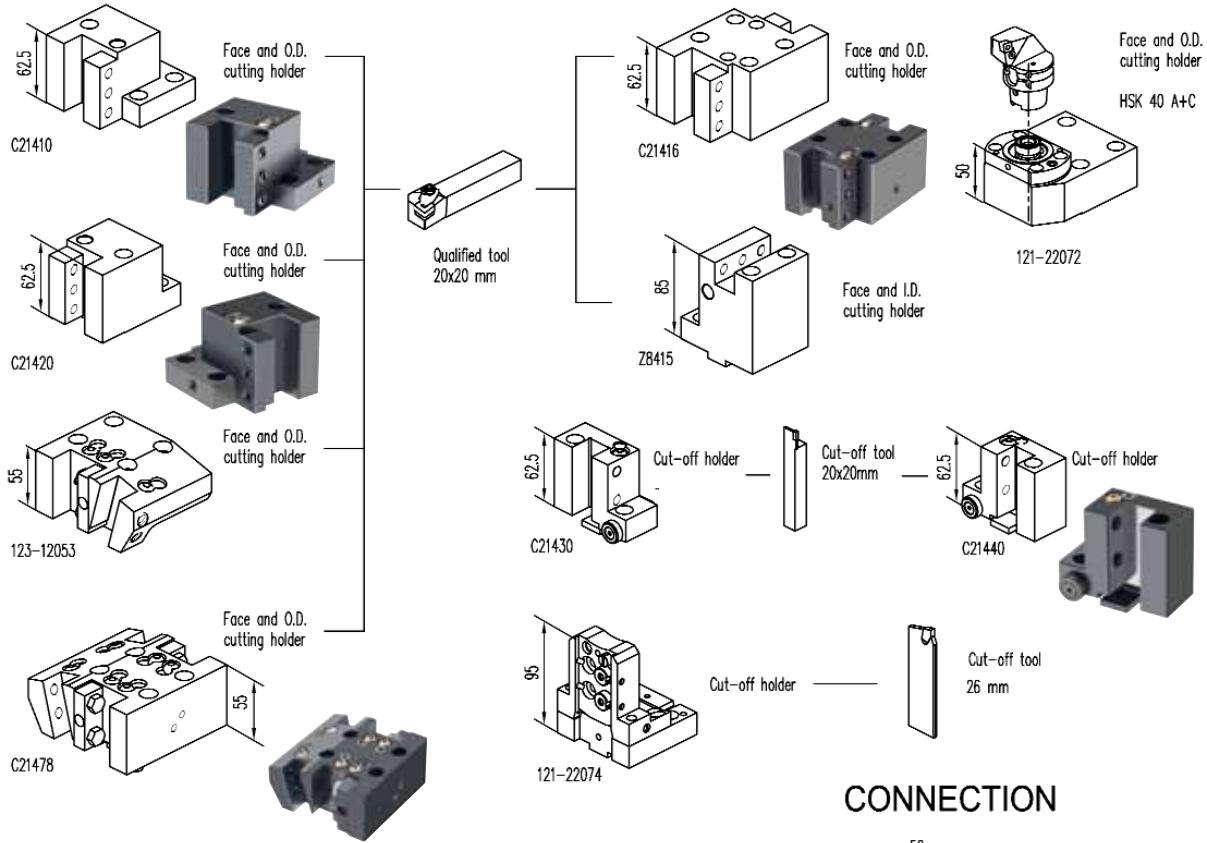

CONNECTION

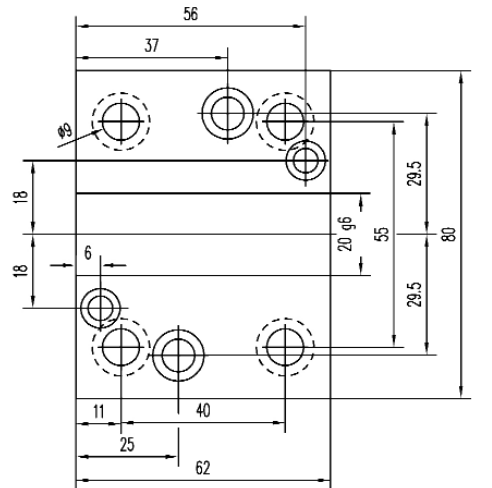

ACCESSORIES

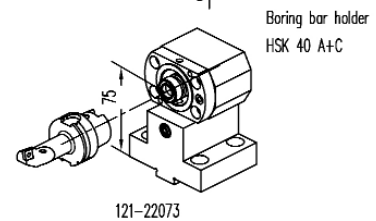
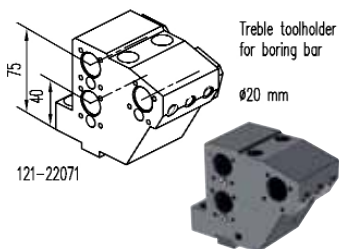
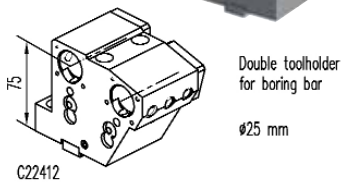
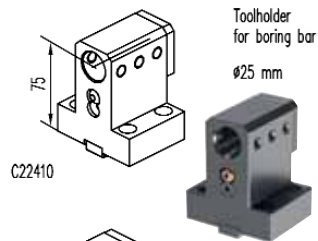

NAKAMURA TOME

WT150 - WTW150 - WTS150
WT250 - SC150 - SC250

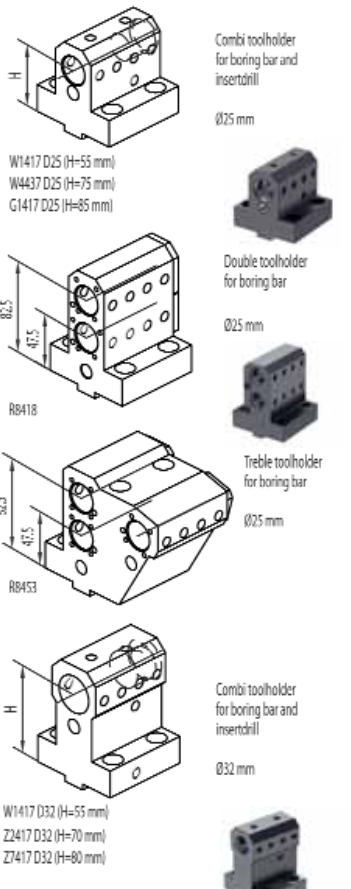
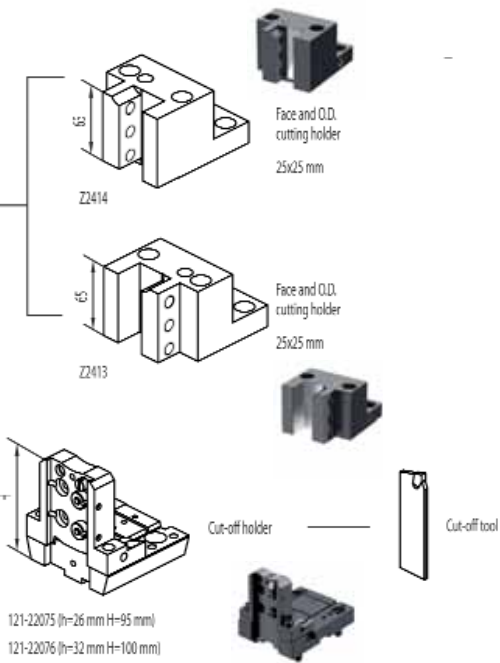
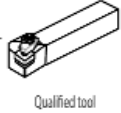
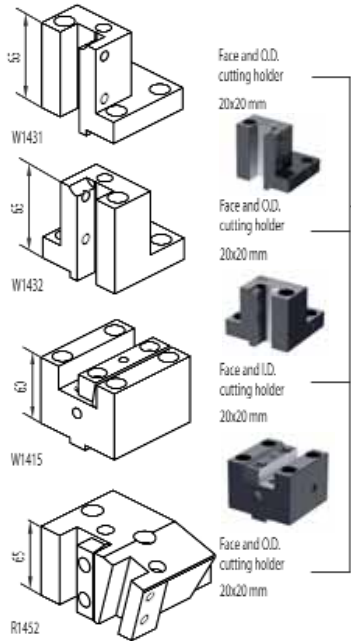

ACCESSORIES

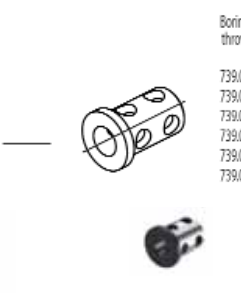

CONNECTION

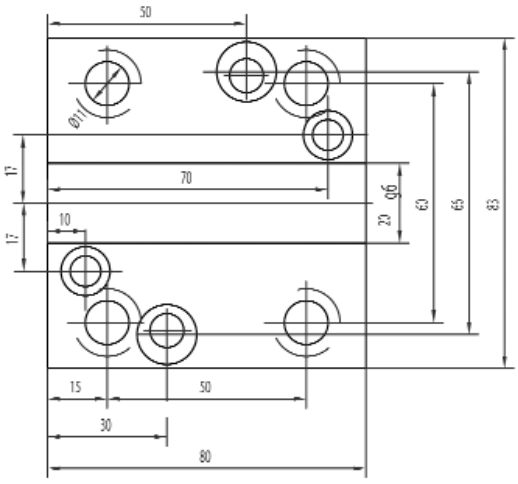

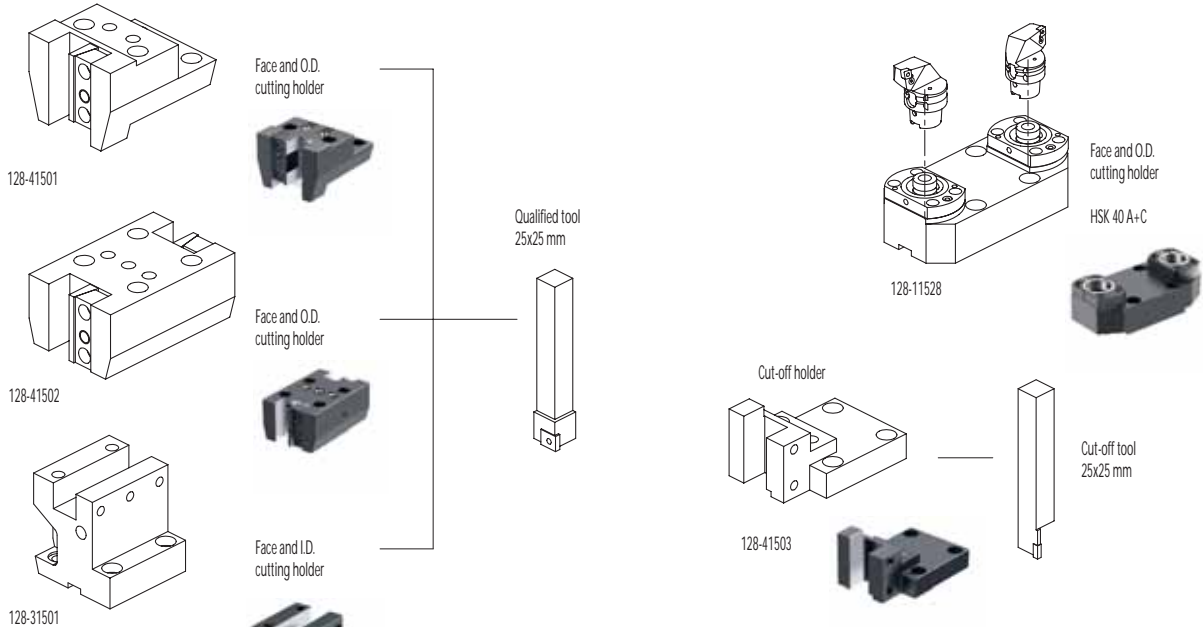

ACCESSORIES

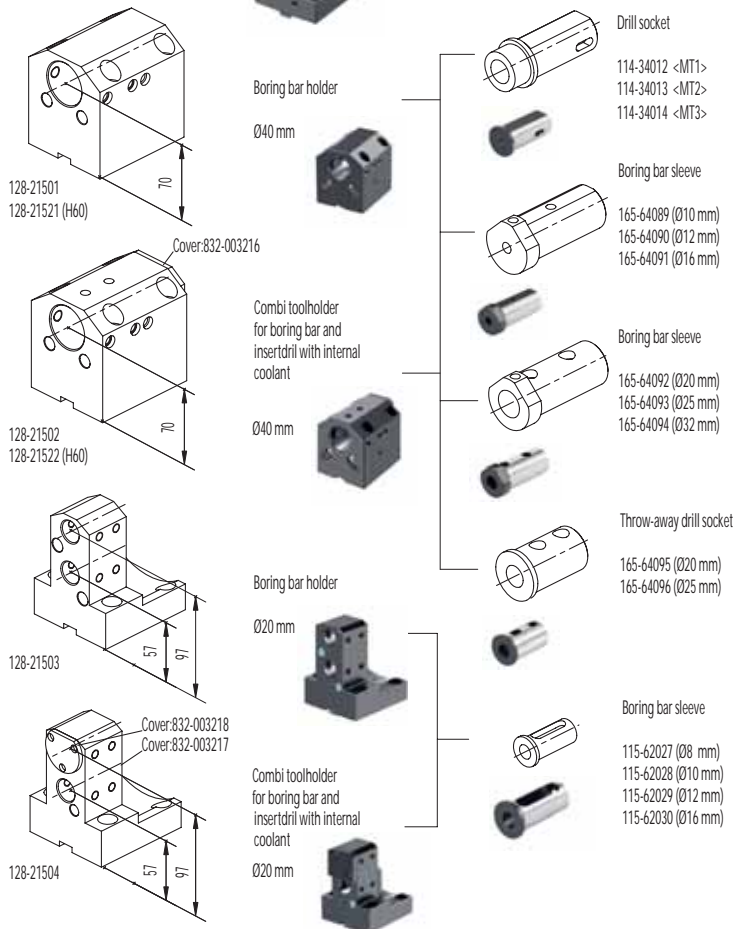

CONNECTION

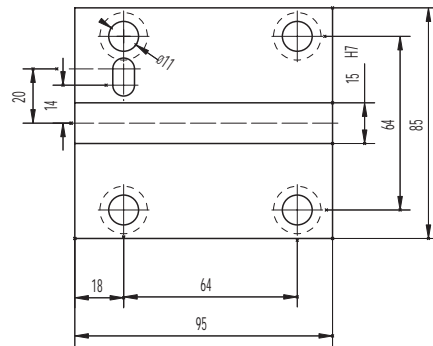

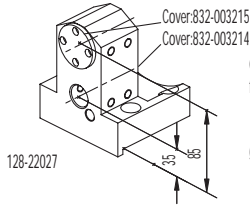
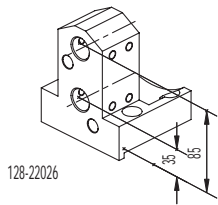
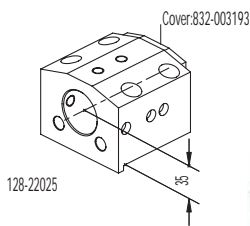
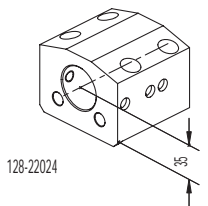
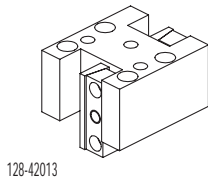
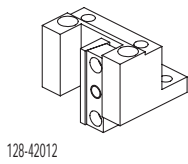
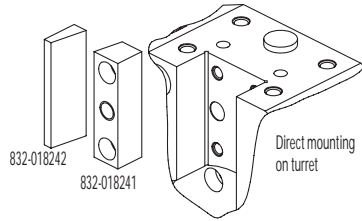

Qualified tool
25x25 mm

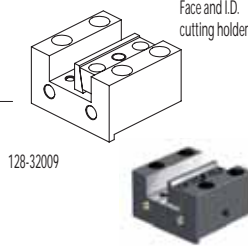

ACCESSORIES

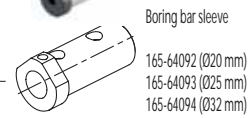
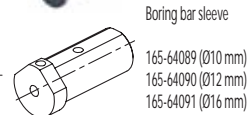
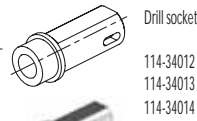

CONNECTION

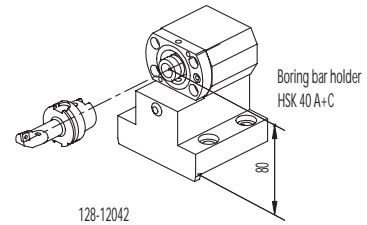
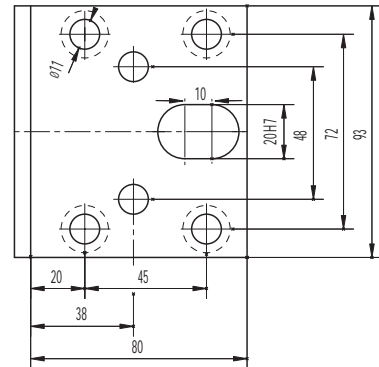

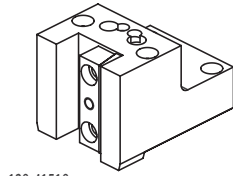

128-41518

Face and O.D.
cutting holder

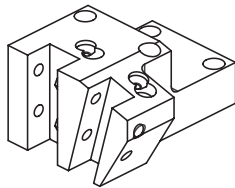

128-41519

Face and O.D.
cutting holder

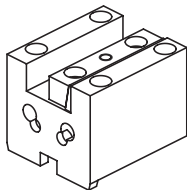

128-31511

Face and O.D.
cutting holder

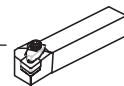

Qualified tool
20x20 mm

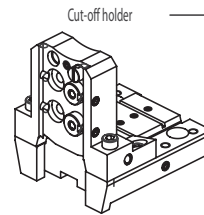

128-11546

Cut-off holder



Cut-off tool
26 mm

ACCESSORIES

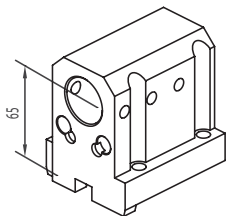

128-21529

Toolholder
for boring bar

Ø32 mm

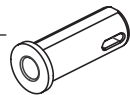

Drill socket

114-33208 <MT1>
114-33209 <MT2>

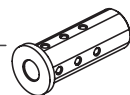

Boring bar sleeve

115-63260 (Ø8 mm)
115-63261 (Ø10 mm)
115-63211 (Ø12 mm)
115-63212 (Ø16 mm)
115-63213 (Ø20 mm)

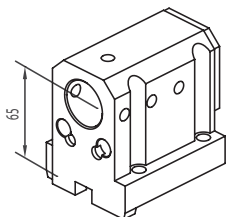

128-21530

Combi toolholder
for boring bar
and insertdrill

Ø32 mm

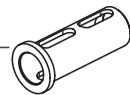

Boring bar sleeve

115-63214 (Ø25 mm)

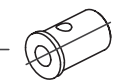

Throw-away drill socket

165-63325 (Ø16 mm)
165-63326 (Ø20 mm)
165-63327 (Ø25 mm)

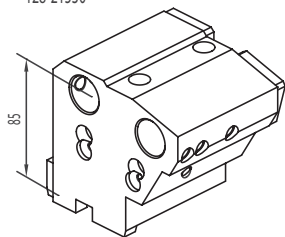

128-21531

Combi toolholder
for boring bar

2xØ25 mm

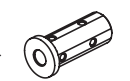

Boring bar sleeve

115-62538 (Ø8 mm)
115-62539 (Ø10 mm)
115-62540 (Ø12 mm)

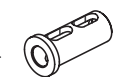

Boring bar sleeve

115-62541 (Ø16 mm)
165-62537 (Ø20 mm)

CONNECTION

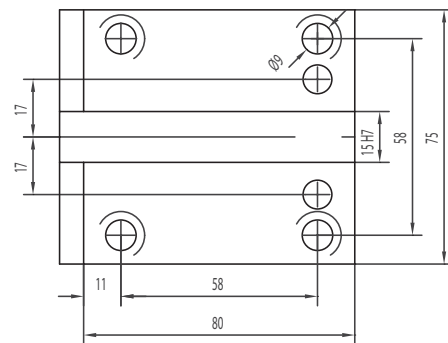

DOOSAN (BMT55)

DOOSAN (BMT55)

PUMA 230-240M/MS - 280LM - 1500-2000-2500M/MS/Y/SY
 2100 SERIE - TT1500-TT1800MS/SY
 TL2000-2500LM - MX1600/2100TS
 LYNX 300M

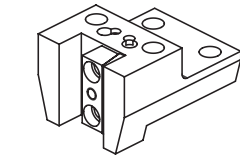

128-41520

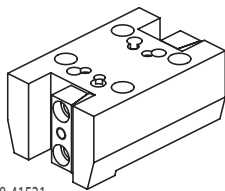

128-41521

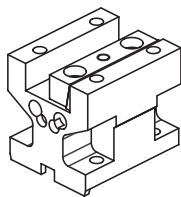

128-31512

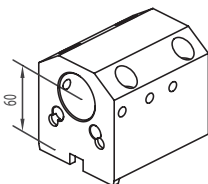

128-21532

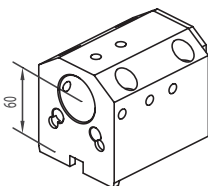

128-21533

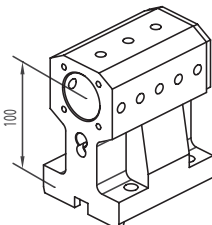

128-21534

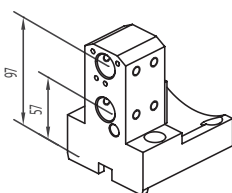

128-21535

Face and O.D.
cutting holder

Face and O.D.
cutting holder

Face and O.D.
cutting holder

Qualified tool
25x25 mm

Face and O.D.
cutting holder

Face and O.D.
cutting holder

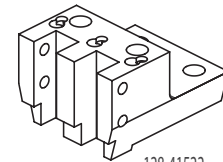

128-41522

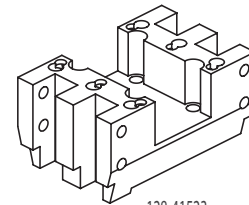

128-41523

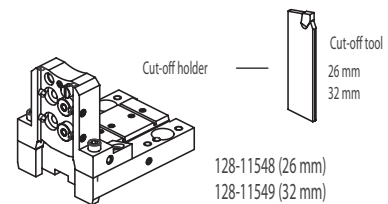

128-11548 (26 mm)
128-11549 (32 mm)

ACCESSORIES

Toolholder
for boring bar

Ø40 mm

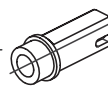

Drill socket

114-34012 <MT1>
114-34013 <MT2>
114-34014 <MT3>

Combi toolholder
for boring bar
and insertdrill

Ø40 mm

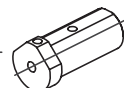

Boring bar sleeve

165-64089 (Ø10 mm)
165-64090 (Ø12 mm)
165-64091 (Ø16 mm)

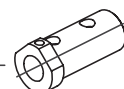

Boring bar sleeve

165-64092 (Ø20 mm)
165-64093 (Ø25 mm)
165-64094 (Ø32 mm)

Combi toolholder
for boring bar
and insertdrill

Ø40 mm

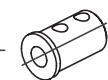

Throw-away drill socket

165-64095 (Ø20 mm)
165-64096 (Ø25 mm)
165-64097 (Ø32 mm)

Combi toolholder
for boring bar
and insertdrill

2xØ20 mm



Boring bar sleeve

115-62027 (Ø8 mm)
115-62028 (Ø10 mm)
115-62029 (Ø12 mm)
115-62030 (Ø16 mm)

Driven tools

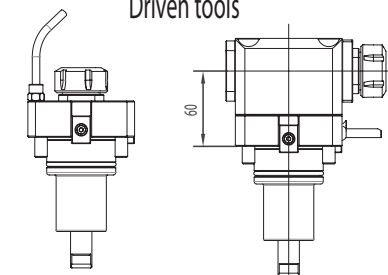

KIN-A04-55A (ER25)

KIN-B04.60-55A (ER25)



CONNECTION

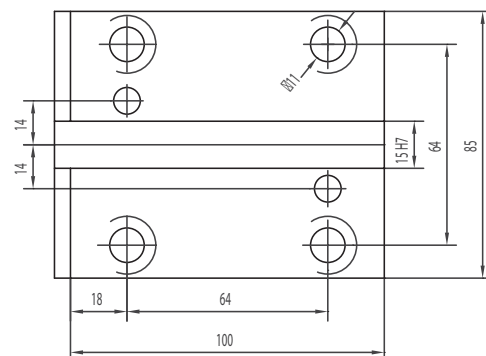

DOOSAN PUMA

(BMT65)

300M/MS - V400M - TT2000SY - TT2500SY
 TT2500MS - 2600/3100 SERIE
 MX2000ST - MX2500T/ST/LST - VT450/TM
 INVERTURN 300M

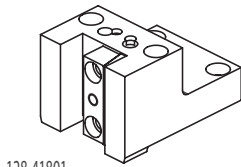

128-41801

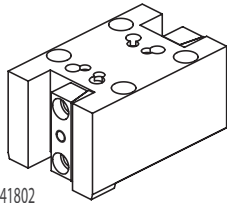

128-41802

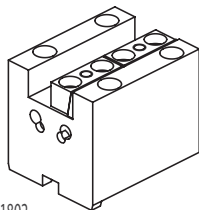

128-31802

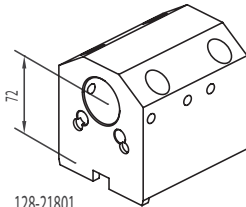

128-21801

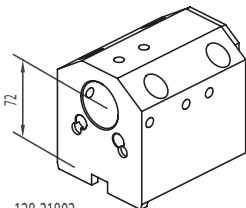

128-21802

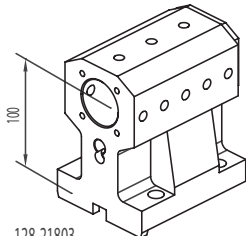

128-21803

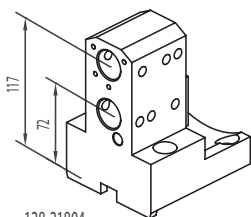

128-21804

Face and O.D.
cutting holder

Face and O.D.
cutting holder

Face and O.D.
cutting holder

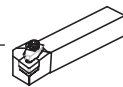

Qualified tool
25x25 mm

Face and O.D.
cutting holder

Face and O.D.
cutting holder

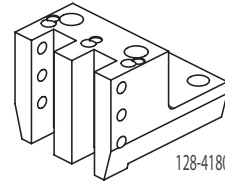

128-41803

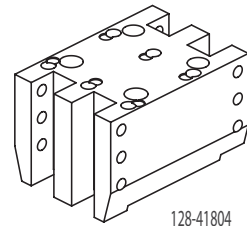

128-41804

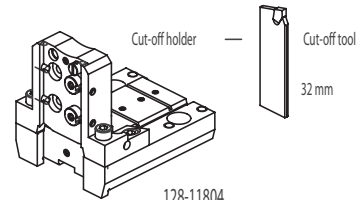

128-11804

ACCESSORIES

Toolholder
for boring bar
Ø40 mm

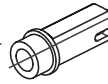

Drill socket

- 114-34012 <MT1>
- 114-34013 <MT2>
- 114-34014 <MT3>

Combi toolholder
for boring bar
and insertdrill
Ø40 mm

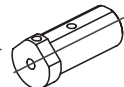

Boring bar sleeve

- 165-64089 (Ø10 mm)
- 165-64090 (Ø12 mm)
- 165-64091 (Ø16 mm)

Combi toolholder
for boring bar
and insertdrill
Ø40 mm

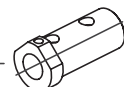

Boring bar sleeve

- 165-64092 (Ø20 mm)
- 165-64093 (Ø25 mm)
- 165-64094 (Ø32 mm)

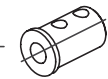

Throw-away drill socket

- 165-64095 (Ø20 mm)
- 165-64096 (Ø25 mm)
- 165-64097 (Ø32 mm)

Combi toolholder
for boring bar
and insertdrill
2xØ25 mm



Boring bar sleeve

- 115-62538 (Ø8 mm)
- 115-62539 (Ø10 mm)
- 115-62540 (Ø12 mm)



Boring bar sleeve

- 115-62541 (Ø16 mm)
- 165-62537 (Ø20 mm)

Driven tools

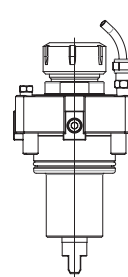

KIN-A05-65A (ER32)

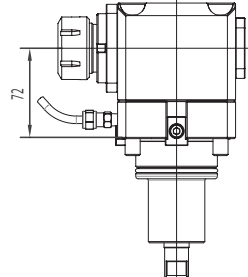

KIN-B05.72-65A (ER32)



CONNECTION

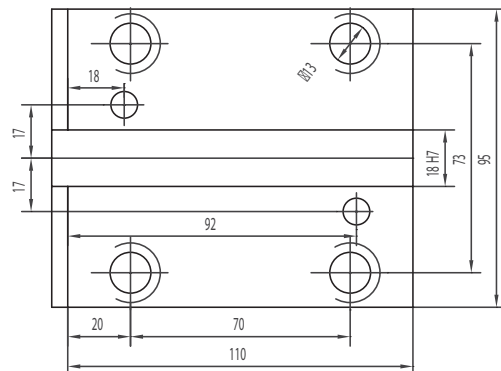

DOOSAN PUMA (BMT75)

400 - 480M/LM/XLM - VT 750M/TM

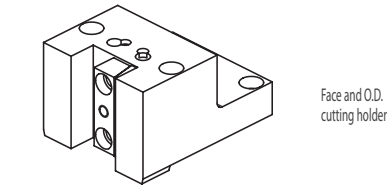

128-42508 25x25 mm

Face and O.D.
cutting holder

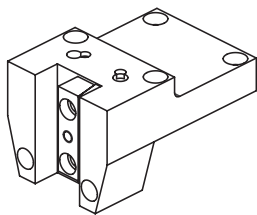

128-42509 25x25 mm

128-42510 32x32 mm

Face and O.D.
cutting holder

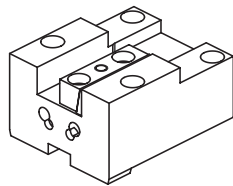

128-32506 25x25 mm

128-32507 32x32 mm

Face and O.D.
cutting holder

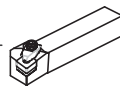

Qualified tool

CONNECTION

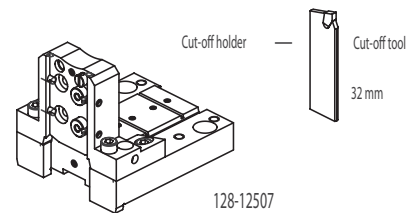
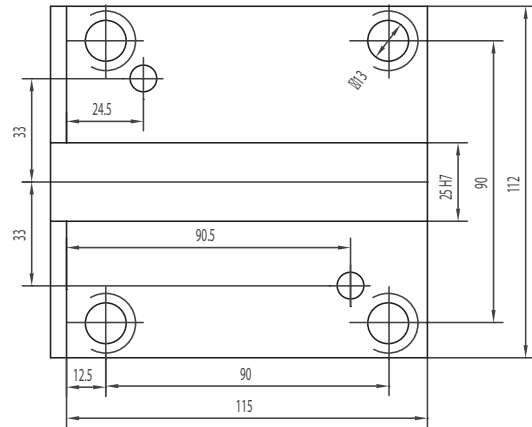

Cut-off holder

Cut-off tool

128-12507

ACCESSORIES

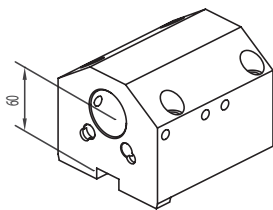

128-22520 Ø40 mm

128-22521 Ø50 mm

Toolholder
for boring bar

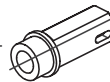

Drill socket Ø40

114-34012 <MT1>

114-34013 <MT2>

114-34014 <MT3>

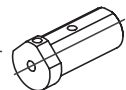

Boring bar sleeve Ø40

165-64089 (Ø10 mm)

165-64090 (Ø12 mm)

165-64091 (Ø16 mm)

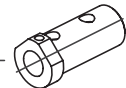

Boring bar sleeve Ø40

165-64092 (Ø20 mm)

165-64093 (Ø25 mm)

165-64094 (Ø32 mm)

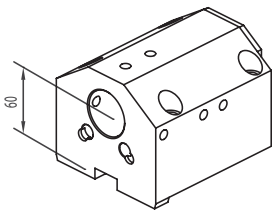

128-22522 Ø40 mm

128-22523 Ø50 mm

Combi toolholder
for boring bar
and insertdrill

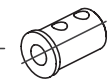

Throw-away drill socket Ø40

165-64095 (Ø20 mm)

165-64096 (Ø25 mm)

165-64097 (Ø32 mm)

Driven tools

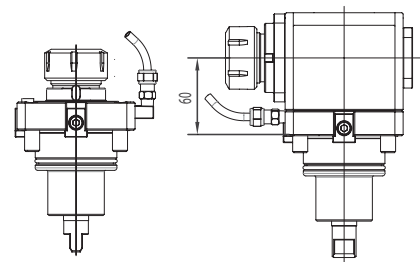

KIN-A05-75A (ER40)

KIN-B06.60-75A (ER40)



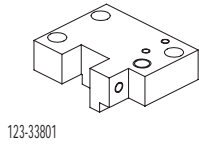

123-33801

Face and O.D. cutting holder

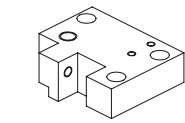

123-33802

Face and O.D. cutting holder

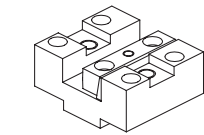

122-13801

Face and I.D. cutting holder



Qualified tool
20x20 mm

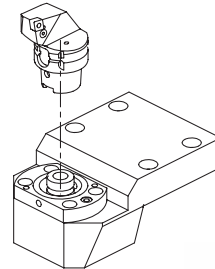

121-23803

Face and O.D. cutting holder

HSK 40 A+C



CONNECTION

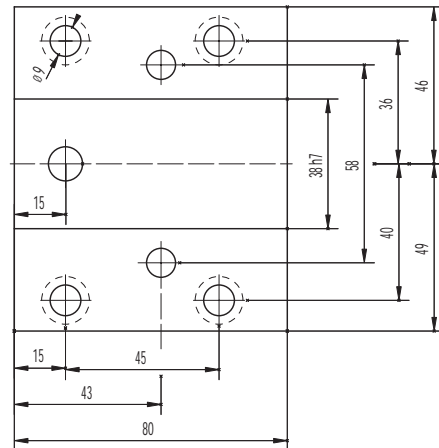

ACCESSORIES

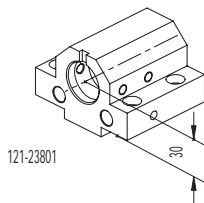

121-23801

Boring bar holder

Ø32 mm

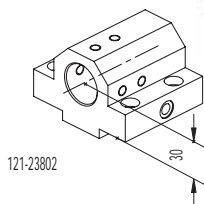

121-23802

Toolholder for insert drill with internal coolant

Ø32 mm

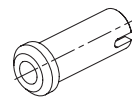

Drill socket

114-33216 <MT2>



Boring bar sleeve

165-63241 (Ø8 mm)
165-63242 (Ø10 mm)
165-63243 (Ø12 mm)
165-63244 (Ø16 mm)

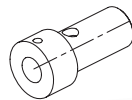

Boring bar sleeve

165-63245 (Ø20 mm)
165-63246 (Ø25 mm)

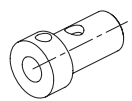

Throw-away drill socket

165-63247 (Ø20 mm)
165-63248 (Ø25 mm)

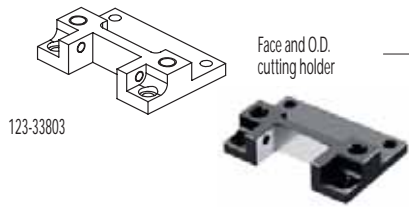

Face and O.D. cutting holder

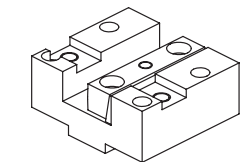

Face and I.D. cutting holder



Qualified tool
25x25 mm

CONNECTION

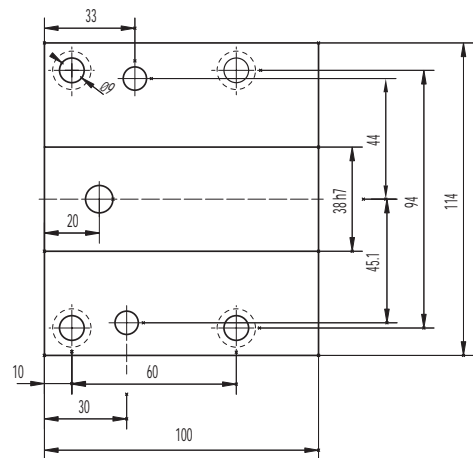

ACCESSORIES

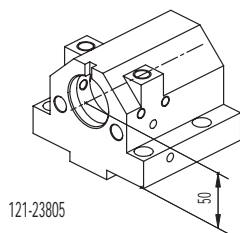

Boring bar holder
Ø40 mm

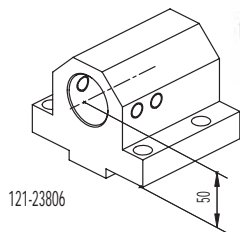

Toolholder for insertdrill with internal coolant
Ø40 mm

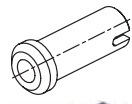
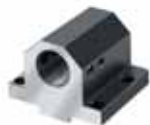

Drill socket

- 114-34015 <MT1>
- 114-34016 <MT2>
- 114-34017 <MT3>



Boring bar sleeve

- 165-64114 (Ø8 mm)
- 165-64115 (Ø10 mm)
- 165-64116 (Ø12 mm)
- 165-64117 (Ø16 mm)
- 165-64118 (Ø20 mm)

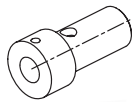

Boring bar sleeve

- 165-64119 (Ø25 mm)
- 165-64120 (Ø32 mm)

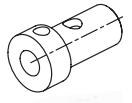

Throw-away drill socket

- 165-64121 (Ø20 mm)
- 165-64122 (Ø25 mm)
- 165-64123 (Ø32 mm)

MAZAK SQT MAZAK QTN (VDI40)

SQT 15, SQT 18 M / MS - 12 Stations
SQT 200, SQT 250 M / MS - 12 Stations
QTN 200, QTN 250 M / MS / MY / MSY - 12 Stations

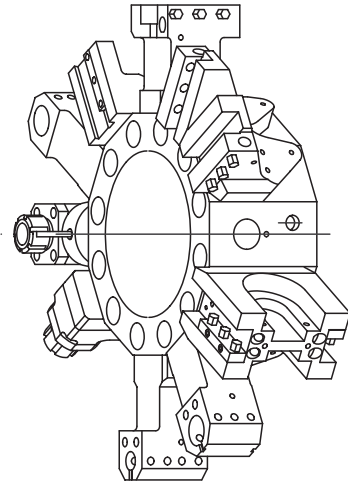
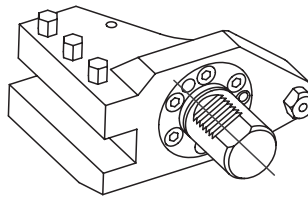
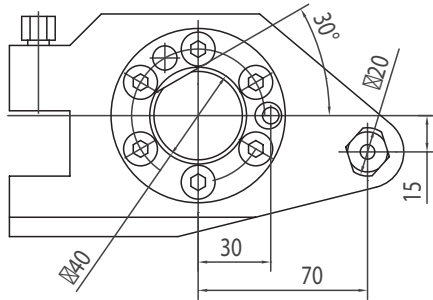

Qualified tool
25x25 mm

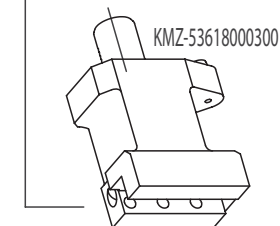
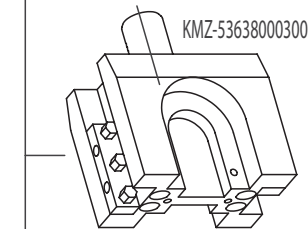
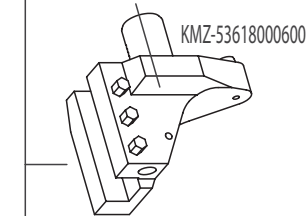
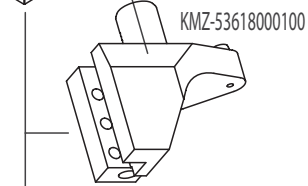
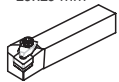

ACCESSORIES

Drill socket

- 114-34015 <MT1>
- 114-34016 <MT2>
- 114-34017 <MT3>

Boring bar sleeve

- 165-64114 (Ø8 mm)
- 165-64115 (Ø10 mm)
- 165-64116 (Ø12 mm)
- 165-64117 (Ø16 mm)
- 165-64118 (Ø20 mm)

Boring bar sleeve

- 165-64119 (Ø25 mm)
- 165-64120 (Ø32 mm)

Throw-away drill socket

- 165-64121 (Ø20 mm)
- 165-64122 (Ø25 mm)
- 165-64123 (Ø32 mm)

Cut-off tool
32 mm

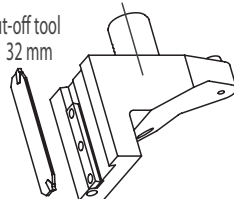

KMZ-53618000400

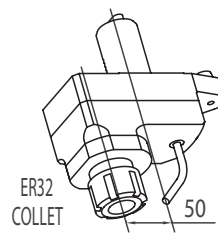
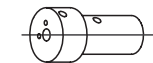
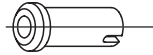

ER32
COLLET

KMZ-40A0LE32E01

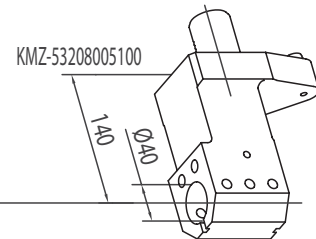

KMZ-53208005100

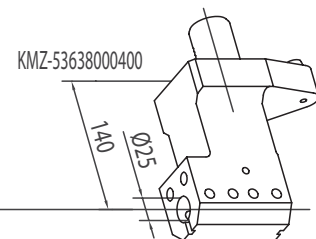

KMZ-53638000400

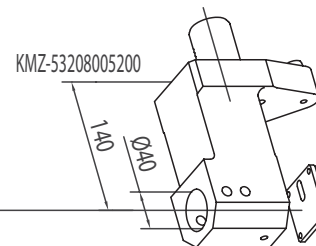

KMZ-53208005200

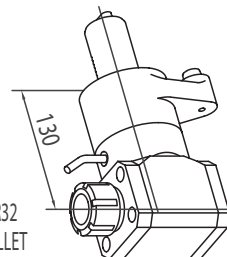

ER32
COLLET

KMZ-40A9LE32E01



ICTM STANDARD



H100APCLNL/R16



H100APDJNL/R15

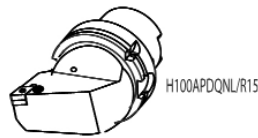

H100APDQNL/R15



H100APSBNL/R19



Axial toolholder.RH
32x32 mm
142-11601

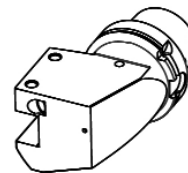

Axial toolholder.LH
32x32 mm
142-21601

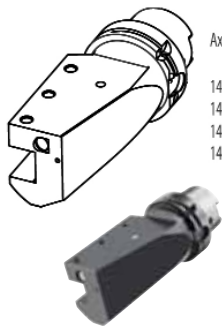

Axial toolholder long
142-21604 (25x25 mm, left)
142-11603 (25x25 mm, right)
142-21603 (32x32 mm, left)
142-11604 (32x32 mm, right)

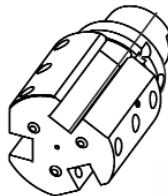

Axial toolholder
25x25 mm
142-21605 (left)
142-11605 (right)

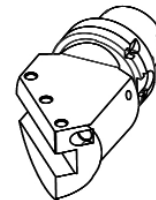

Toolholder 45°
25x25 mm
141-11601

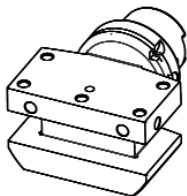

Toolholder with multiple seats
32x32 mm
143-11601

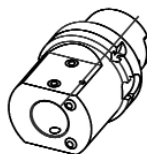

Boring bar holder
Ø40 mm
145-21605

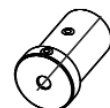

Boring bar sleeve
165-64124 (Ø10 mm)
165-64125 (Ø12 mm)
165-64126 (Ø16 mm)
165-64127 (Ø20 mm)



Boring bar sleeve
165-64128 (Ø25 mm)
165-64129 (Ø32 mm)

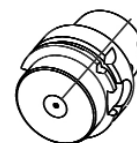

Blanking plug
140-30006 (HSK63A)
140-30007 (HSK100A)

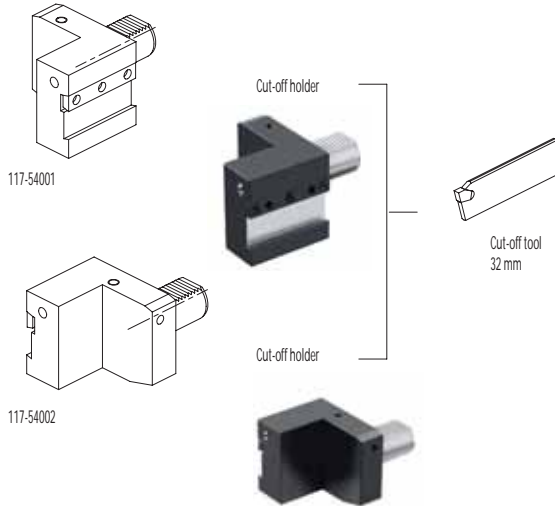

ACCESSORIES

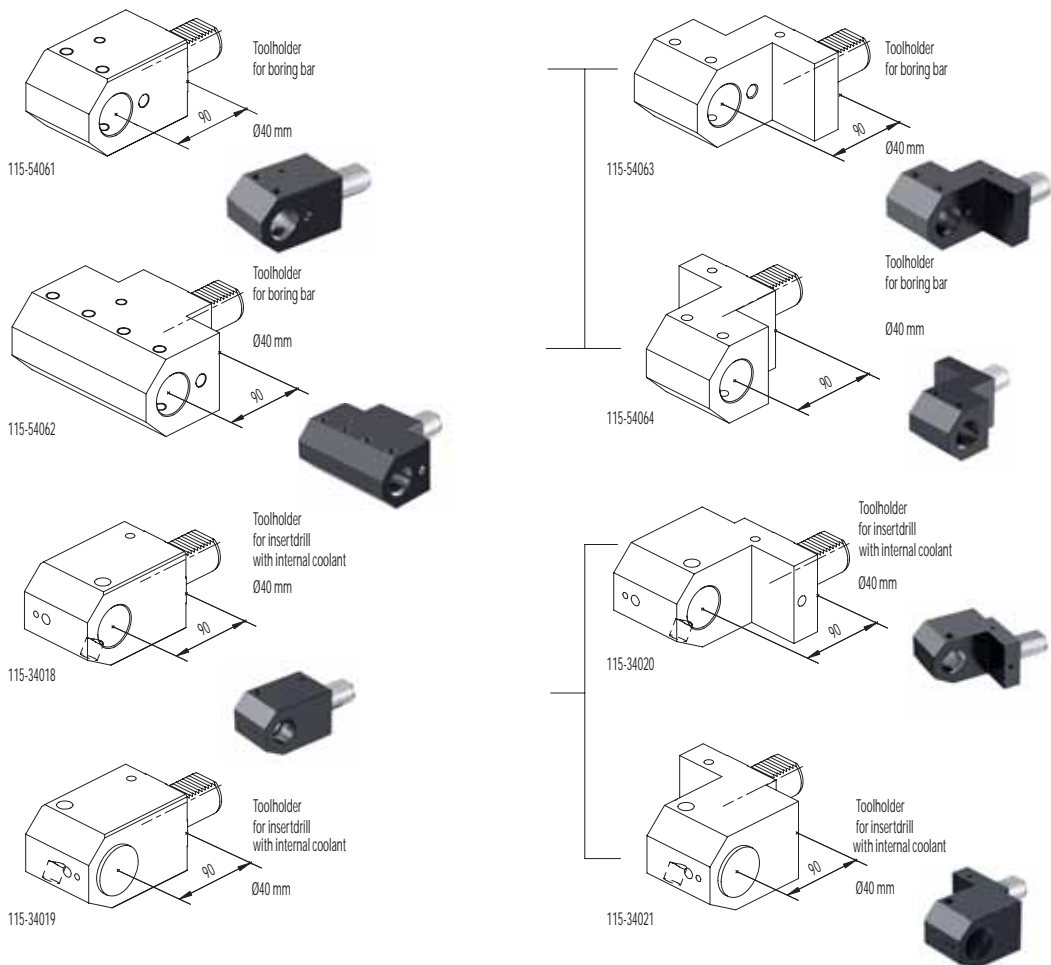

YOU JI

VTL1000,1200,1600,2000,2500
YV1000,1200,1600

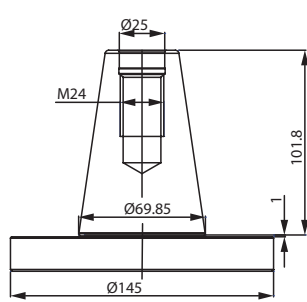

ATC series

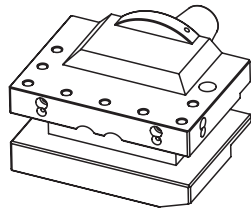

Face and O.D. cutting holder

153-11501 32x32 L160

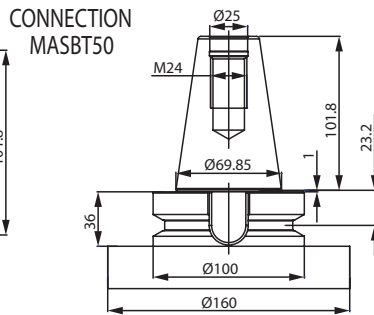

ATC+C series
(Turning tool)

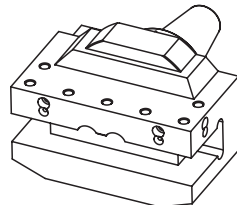

153-11504 32x32 L160

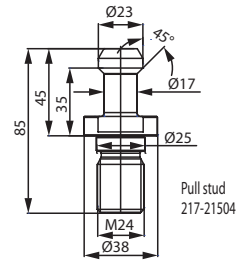

ATC+C series
(Driven tool)

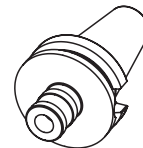

Tension and compression tapping head

M3320 BT50H81GR1.DC
M3430 BT50H102GR2.DC
M3530 BT50H135GR3.DC

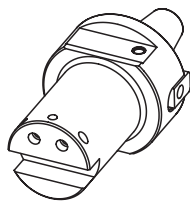

Face and O.D. cutting holder

151-11505 25x25 L200

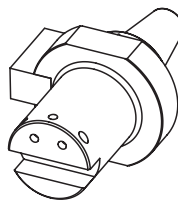

151-11504 25x25 L200

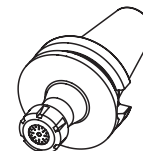

ER collet chuck

214-31438 BT50H100ER25 AD+B
214-31434 BT50H100ER32 AD+B
214-31436 BT50H100ER40 AD+B

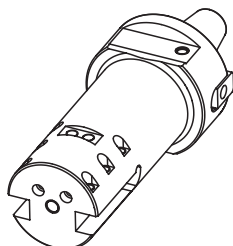

Face and I.D. cutting holder

152-11507 25x25 L300

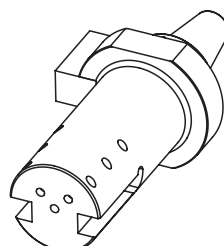

152-11508 25x25 L300

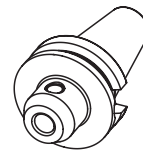

End mill holder

213-11430 BT50H80WE20 AD+B
213-11431 BT50H100WE25 AD+B
213-11432 BT50H105WE32 AD+B
213-11433 BT50H120WE40 AD+B

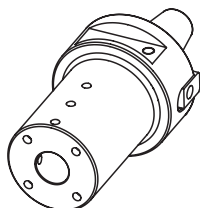

Toolholder for boring bar

155-21503 D40 L215
155-21506 D60 L215
155-21505 D60 L315

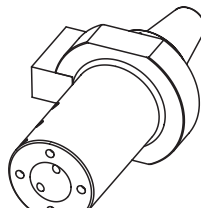

155-21510 D40 L250
155-21508 D50 L250
155-21509 D60 L250

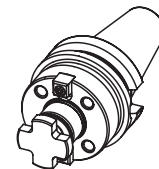

Facemill holder

216-71520 BT50H60D32F
216-21502 BT50H70D40
216-21503 BT50H80D60

SONDERWERKZEUGHALTER
SPECIAL TOOLS
СПЕЦИАЛЬНЫЕ ИНСТРУМЕНТЫ

PORTE-OUTILS SPÉCIAUX
PRODOTTI SPECIALI
特殊工具

